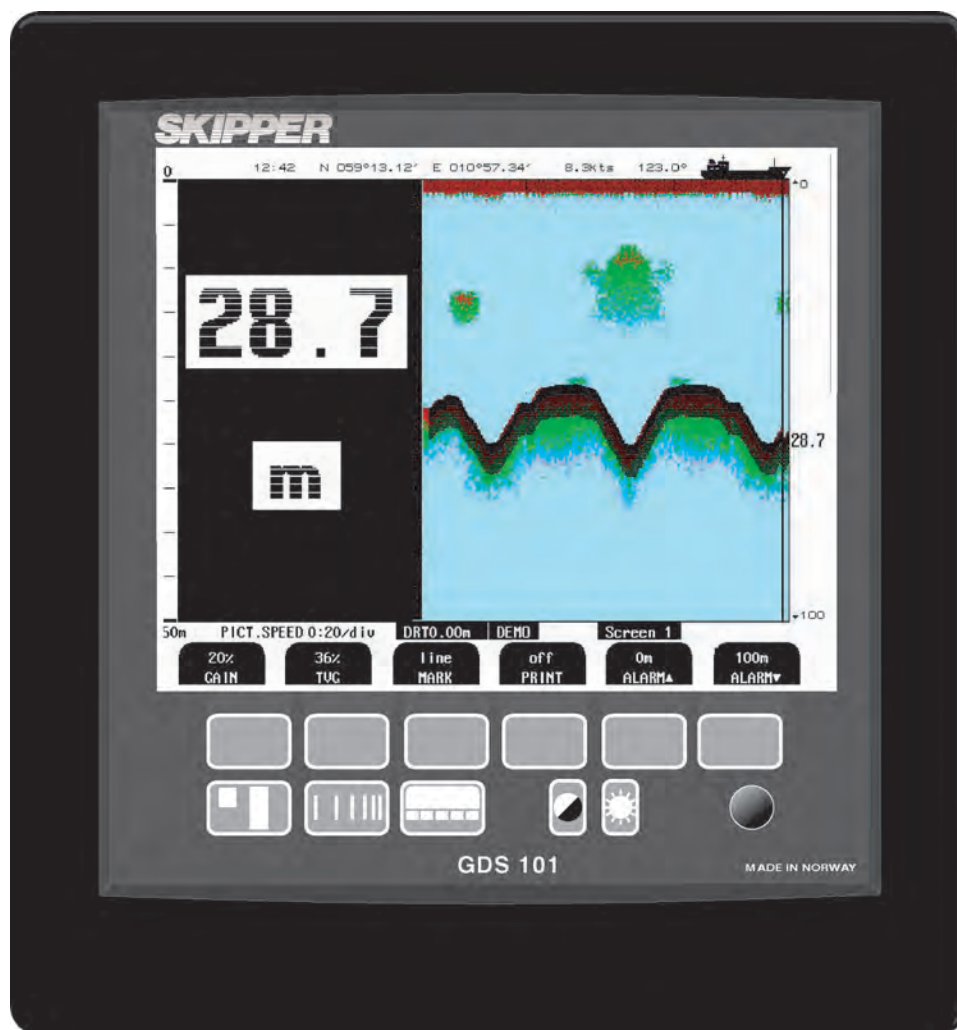


# SKIPPER

## Graphic Depth Sounder

# GDS101

## Operation and Installation Manual



SKIPPER Electronics AS  
Enebakkveien 150  
P. O. Box 151, Manglerud  
0612 Oslo, Norway  
[www.skipper.no](http://www.skipper.no)

Telephone: +47 23 30 22 70  
Telefax: +47 23 30 22 71  
E-mail: [support@skipper.no](mailto:support@skipper.no)  
Co. reg. no: NO-965378847-MVA

Document no: DM-G001-SB Rev 05.05.09A  
Edition: 20100225

Weitergabe sowie vervielfältigung dieser unterlage, verwertung und mitteilung ihres inhaltes nicht gestattet, soweit nicht ausdrücklich zugestanden. Zuwiderhandlungen verpflichten zu schadenersatz.

Toute communication ou reproduction de ce document, toute exploitation ou communication de ou son contenu sont interdites, sauf autorisation expresse. Tout manquement à cette règle est illicite et expose son auteur au versement de dommages et intérêts.

Copying of this document, and giving it to others and the use or communication of contents thereof, are forbidden without express authority. Offenders are liable to the payment of damages.

Sin nuestra expresa autorización, queda terminantemente prohibida la reproducción total o parcial de este documento, así como su uso Indebido y/o su exhibición o comunicación a terceros. De los infractores Se exigirá el correspondiente resarcimiento de daños y perjuicios.

# Contents

1. INTRODUCTION .....	5
SYSTEM SUMMARY .....	5
TRANSDUCERS.....	5
OPERATOR PANEL AND DATA ENTRY .....	5
RECORDED DATA STORAGE .....	6
INTERFACING.....	8
Outputs .....	8
Inputs.....	8
ALARMS .....	8
OPTIONS .....	8
Repeaters.....	8
Remote Sounding Control.....	8
Auto Range.....	8
Sound Speed Calibration.....	8
2. OPERATION .....	10
PARAMETER ENTRY .....	10
Example of parameter entry .....	11
OPERATION SCREENS .....	11
Primary Operation Screens .....	12
Secondary Operation Screens .....	15
PRINCIPAL FUNCTIONS .....	22
Bottom detection.....	22
Ping to Ping filtering .....	22
Bottom Search Range.....	22
System (Power) On/Off.....	22
Alarm acknowledgement .....	22
FIXED KEY FUNCTIONS.....	23
Depth Range.....	23
Picture Speed.....	23
Screen Select.....	23
Day/Night and back light adjustment.....	23
SOFT KEY FUNCTIONS .....	24
Gain .....	24
TVG.....	24
Digital indication.....	24
Frequency.....	24
Output Power .....	24
Draught.....	24
External Printer Operation .....	24
Alarm Settings.....	25
Clock and Calendar Settings .....	25
History Memory .....	25
Simulator .....	26
Status Screen .....	26
Oscilloscope Screen .....	26
Nonvolatile Parameter Memory .....	26
OPTIONS.....	26
Repeaters/Slaves .....	26
Remote Sounding Control.....	26
Auto Range.....	26
Sound speed calibration .....	26
External Printer .....	26

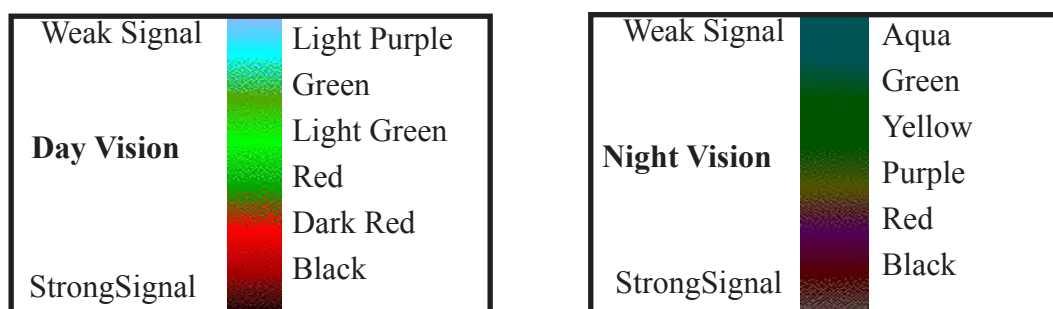
3. USER MAINTENANCE .....	27
TRANSDUCER MAINTENANCE.....	27
OPERATOR UNIT MAINTENANCE .....	27
TYPICAL STATUS SCREEN (9) CONTENTS.....	29
TYPICAL OSCILLOSCOPE SCREEN (10) CONTENTS .....	31
4. INSTALLATION .....	33
STANDARD SYSTEM SUPPLY .....	33
TRANSDUCER INSTALLATION.....	33
Location.....	33
Installation Details .....	33
TRANSDUCER JUNCTION BOX .....	35
EMC.....	37
POWER INDICATION AND FUNCTION LEDs.....	40
INTERFACING.....	42
Alarm relay.....	42
External alarm reset function .....	42
Log Pulse input .....	43
Remote Transducer Selector FEEDB (Feedback).....	43
Transmitter and Bottom Pulse outputs.....	43
Analogue interfaces.....	43
External Interface Ports.....	47
OPTIONS.....	48
Repeaters/Slaves .....	48
Remote Keyboard.....	48
Remote Sounding Control.....	48
5. START-UP AND SYSTEM ADAPTION .....	49
SYSTEM ADAPTATION.....	49
Analogue Output and Log Pulse Input Range Selection.....	49
Language and Units of Measure .....	49
Remote Transducer Selector .....	49
Low frequency indication .....	49
NMEA Setup .....	50
OPTIONS.....	51
Calibration, Sound Speed.....	51
External Ping Control.....	51
6. SPECIFICATIONS, DIMENSIONS.....	52
Transducer and Junction Box.....	54
Operator Unit Cabinet.....	54
7. SERVICE .....	55
8. CPU BOARD SETUP PROCEDURE .....	56
CPU PCA 6742VE.....	56
MASTER RESET PROCEDURE .....	57
UPGRADING SOFTWARE.....	57
9. APPENDIX MISCELLANEOUS INSTALLATION DRAWINGS .....	58
FIG 9.1 TRANSDUCER SELECTOR CONNECTION .....	59
FIG 9.2 TRANSDUCER SELECTOR .....	60
FIG 9.3 CABLE GLAND CONNECTION .....	61
FIG 9.4 EMC MOUNTING KIT.....	62

## 1. Introduction

### System Summary

GDS101 is a navigation echo sounder with a large high resolution graphic LCD. The echo sounder graphics are continuously shown on the LCD along with complete navigational details.

The colour bar:



It is possible to connect an external printer to the operator unit. The sounder contains a 24 hour history memory that can be printed out. Depth, time and all available navigation data are stored continuously so that the last 24 hours of information is always available. All this information may also be printed on the external printer. All IMO requirements are met or exceeded. Comprehensive interfaces are available including IEC 61162-1:2007(E) (NMEA 0183) inputs and outputs.

### Transducers

GDS101 is prepared for connection to transducers of the following frequencies: 38, 50 and 200 kHz. One or more of the transducers may be connected at the same time, and the desired transducer may be selected from the operator panel.

### Operator Panel and Data Entry

The operator unit contains a graphic LCD and a keyboard with fixed keys, soft keys and a rotating encoder. The function of each soft key button depends on the active screen, and the buttons are labeled on the lower rim of the LCD. The display is backlit, and contrast and backlight intensity may be adjusted by the user. The echo gram is displayed continuously on the LCD and stored in the 24 hour history memory. An optional external printer is used if hard-copy documentation is required. The operator unit is normally flush mounted. Power supply options are 115/230 V AC or 24 V DC. The power consumption is app. 70 Watt at 115/230 V AC or 50 Watt at 24 V DC.

Several screens may be selected to enter various settings and calibration parameters. Each screen has a selection of soft key buttons. Screens 1 through 3 are primary operation screens with appropriate operator controls. Screens 4 through 10 are calibration setup and system supervision screens. The various screens will be described in detail later.

### Recorded Data Storage

The measured depth and other navigational data is continuously stored in the 24 hour history memory. A standard printer HP Deskjet or Epson D88/LQ300 (all with Centronics parallel interface) may be connected for paper copy. Ask SKIPPER for specification.

#### **WARNING!**

False bottom echoes may occur when:

- The bottom is out of range.
- Extreme noise conditions are present.
- Bottom signal may be lost for other reasons, like wakes or aeration below transducer.

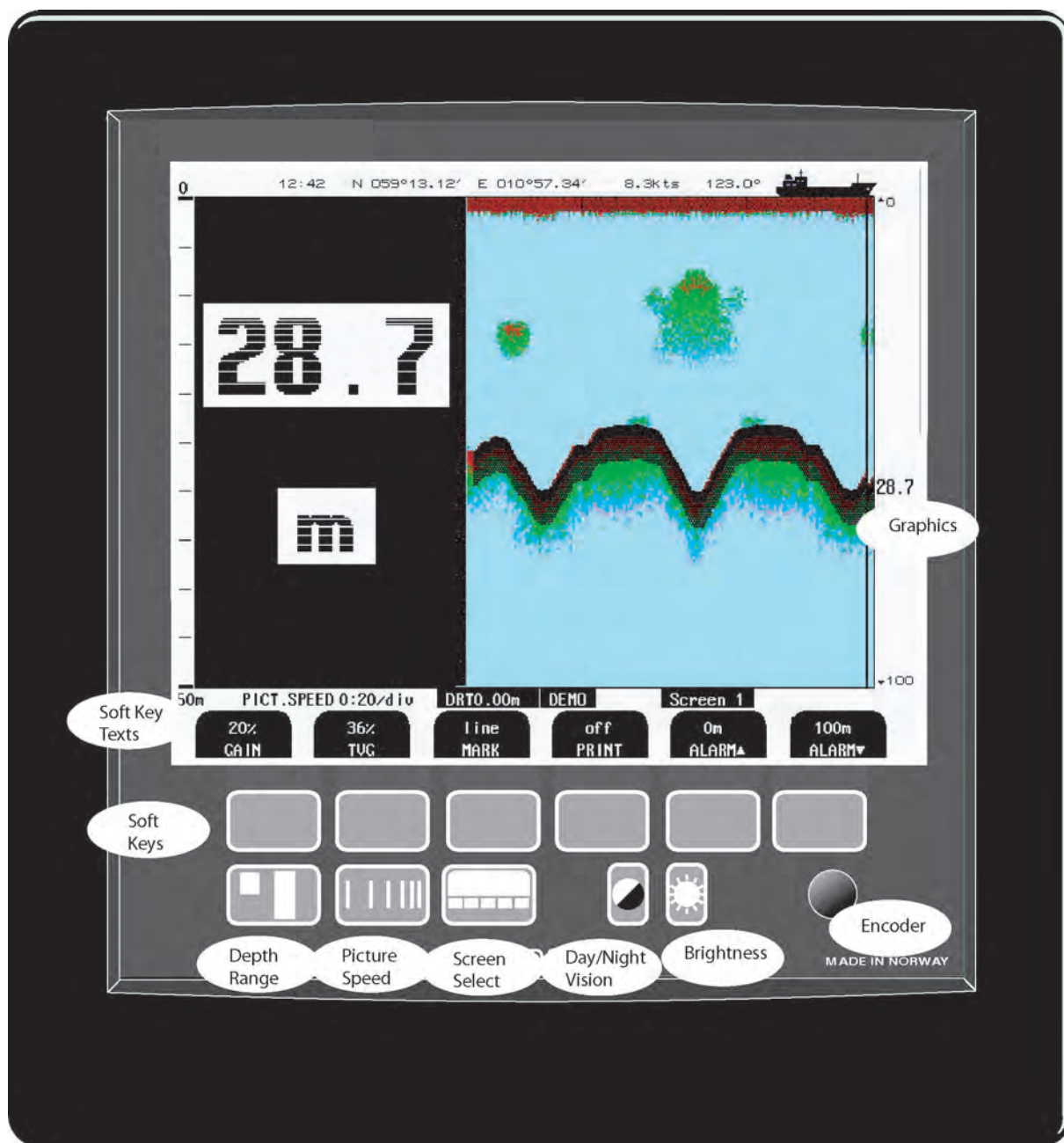


Fig. 1.1 Main Display Unit Panel Layout

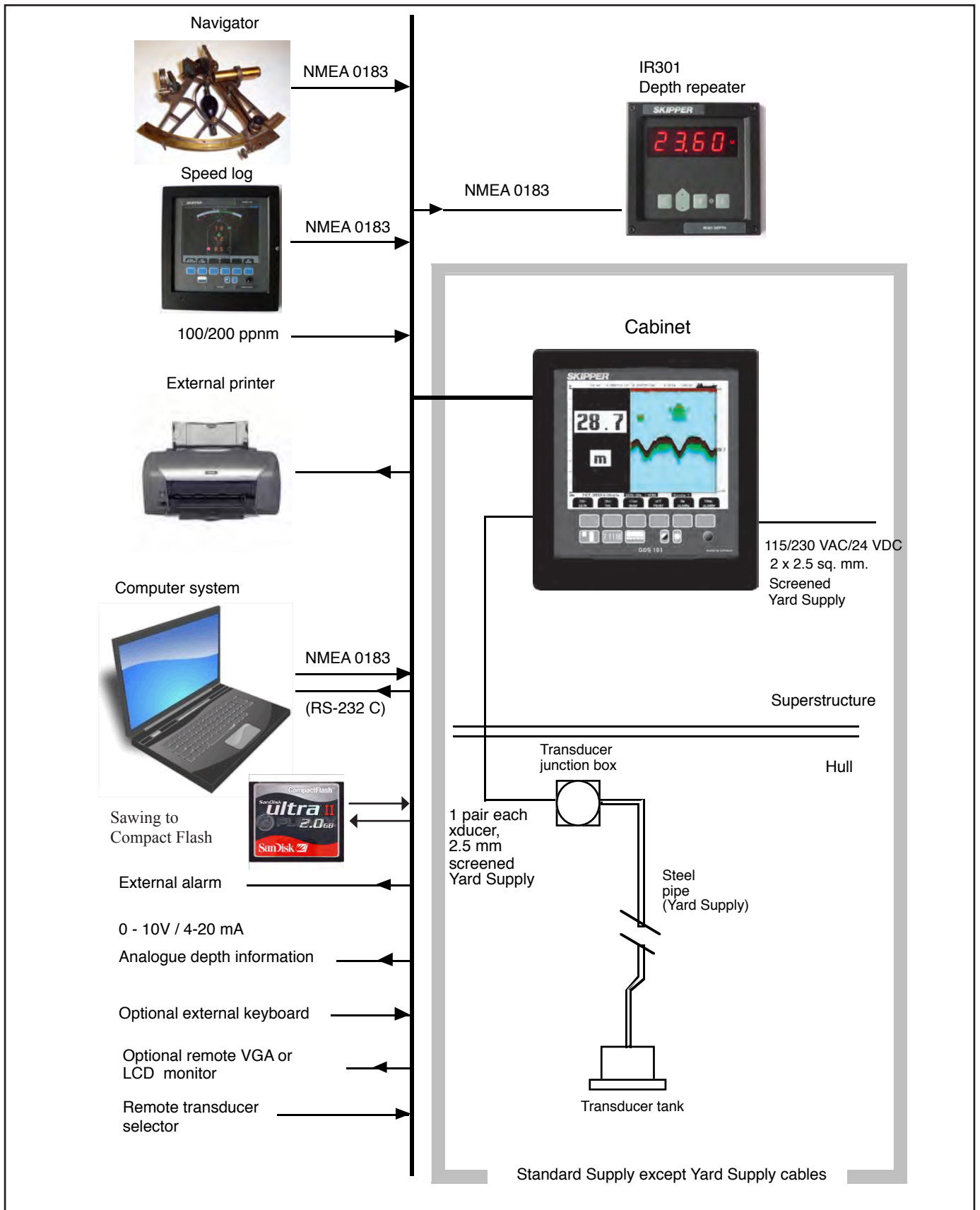


Fig. 1.2 System Diagram

## Interfacing

The GDS101 has several interface possibilities.

### Outputs

- Trigger and bottom pulse outputs.
- Analogue output 0 - 10 V or 4 - 20 mA.
- IEC 61162-1:2007(E) (NMEA 0183).
- External alarm relay output.
- External printer.
- External VGA monitor.

### Inputs

- Log input 100/200/400/20000 pulses per nautical mile.
- IEC 61162-1:2007(E) (NMEA 0183) interface input of position, heading, speed and UTC.
- Remote control and synchronisation of transmitter. (Option).
- Remote transducer switch.
- Remote keyboard.
- Remote alarm reset.

## Alarms

Shallow and deep water alarms may be selected from screen 1. A potential free relay contact is provided in GDS101 for interface to external alarm systems.

## Options

### Repeaters

Graphic CRT or LCD display or digital depth slave repeaters may be connected to the system. Along with the graphic display repeaters, there may also be installed a remote keyboard.

### Remote Sounding Control

\* This option lets the GDS101 being remote controlled in synchronized, burst or single ping modes.

### Auto Range

This option will automatically adjust the depth range to maintain the bottom contour within the middle half of the screen.

### Sound Speed Calibration

\* This option will enable adjustment of the sound speed value used for the depth calculations.

\***Note:** These options can not be used with IMO approval.



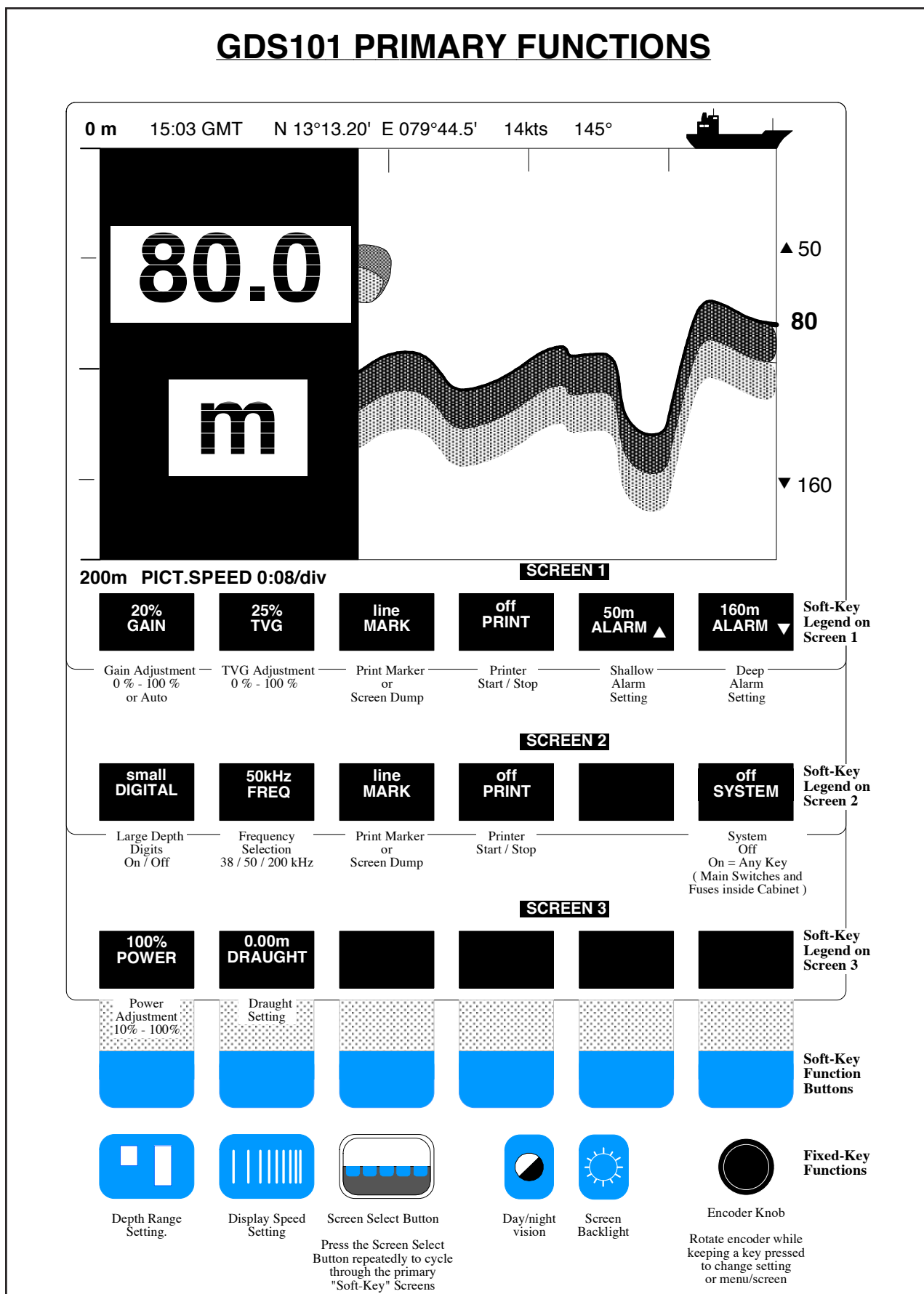


Fig 1.3 GDS101 Primary Functions

## 2. Operation

When the installation is complete, and power is connected to the operator unit, the system is switched on-off by power switch(es) inside the cabinet.

### Parameter entry

The fixed function and soft key buttons of the various screens along with the rotating encoder, facilitates entry of parameters, setpoints and other data. The following flowchart illustrates the procedure for changing settings and entering data. The various screens are shown in detail in the operation section.

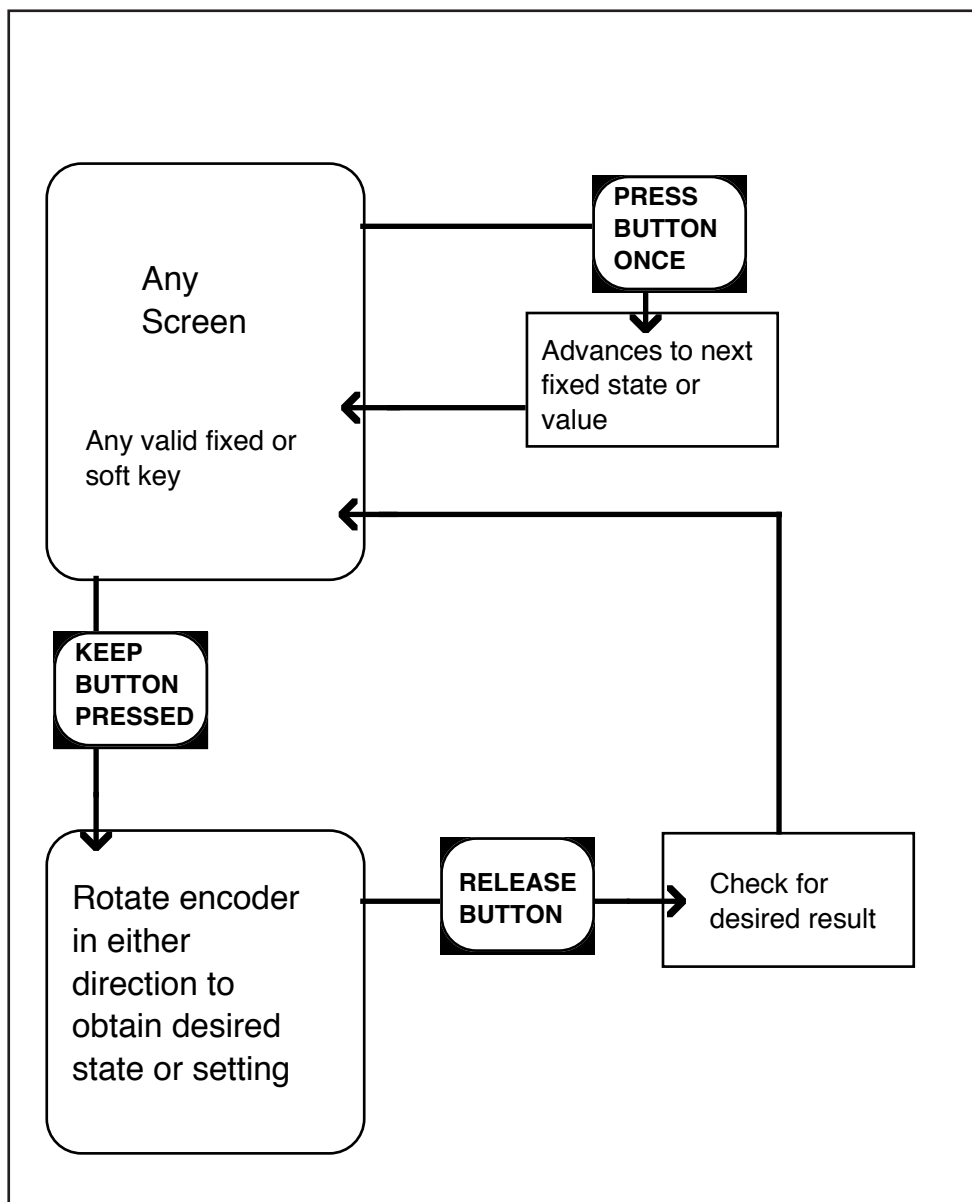


Fig. 2.1 Setting and Parameter Entry Flowchart

### **Example of parameter entry**

Suppose you want to enter a value of 800 m for the depth range. Press the DEPTH RANGE button several times and observe the depth range sequencing through the standard values 10, 50, 100, 500, 1000 m. Press till the range is 500 m. Then press the DEPTH RANGE button again and keep it pressed while you turn the encoder clockwise. Observe the depth range increase to 800 m, release the encoder and the DEPTH RANGE button. You could also have started from the standard value 1000 m and decreased to 800 m by turning the encoder counter-clockwise.

Buttons with less than 6 possible states or values can be operated without using the encoder at all.

### **Operation Screens**

Each of the operation screens contains a graphic picture and a selection of up to 6 soft key buttons. The various screens are selected by keeping the SCREEN SELECT button pressed and rotating the encoder in either direction. Turning the encoder clockwise cycle the screens in the sequence 1 to 10, and counter clockwise rotation cycles the screens in the sequence 10 to 1. Screens no. 1, 2 and 3, covering the primary functions, may also be cycled by repeatedly pressing the SCREEN SELECT button.

The screen layouts are outlined in fig. 2.2 through 2.11. The various soft key functions are described with each screen.

Primary Operation Screens

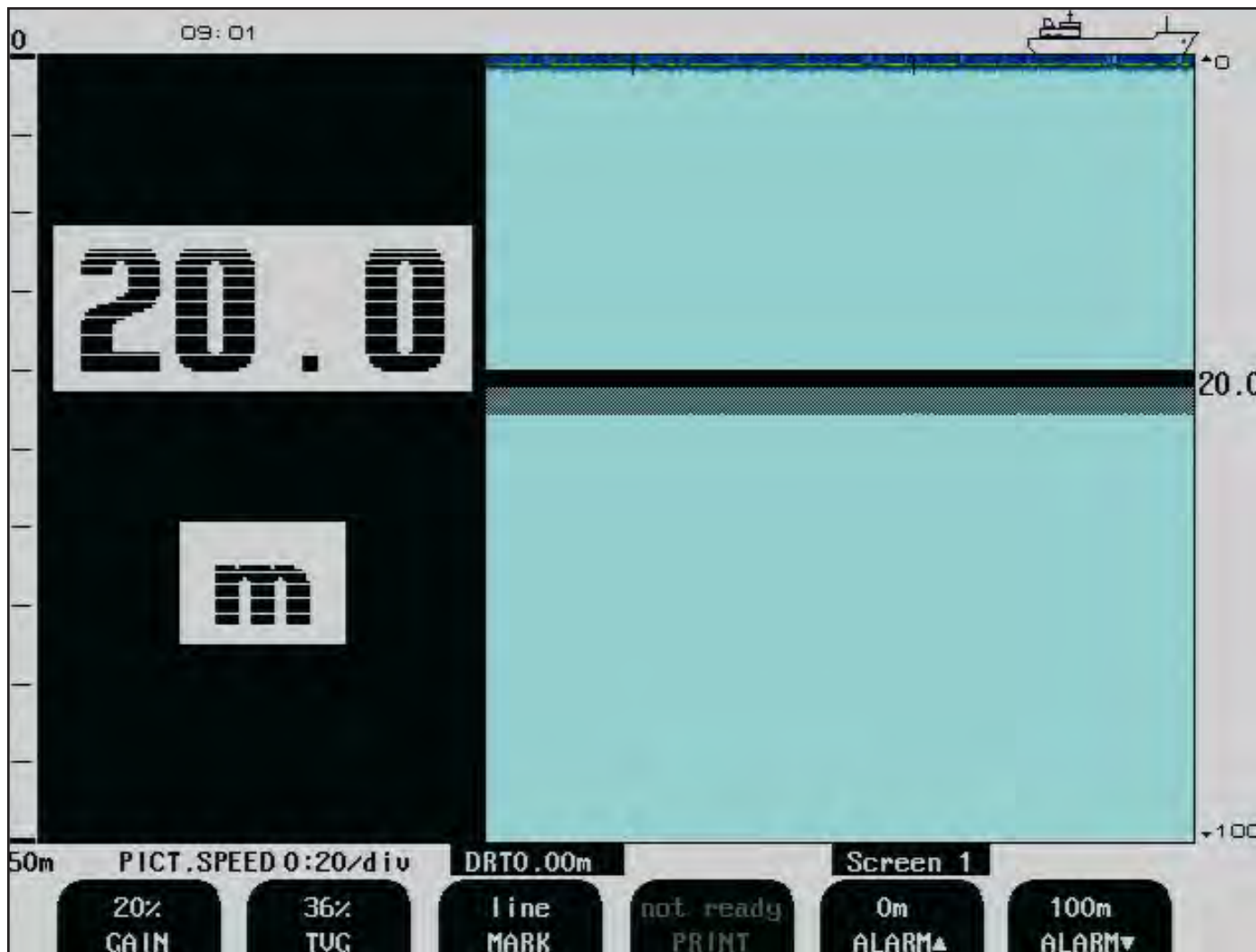


Fig. 2.2. Screen 1, Primary Operation screen.

This screen shows the main graphic echo gram. Left hand digital indication may be enabled from screen 2.

Soft key	Name	Range/value	Default value	Description
1	GAIN	0 - 100 %	20 %	Gain adjustment. (100 % is max. gain).
2	TVG	0 - 100 %	36 %	Time Variable Gain adjustment. (0 % is max suppression). Suppression of echoes from 0 - 40 meter.
3	MARK	Line		Print mark line/print screen.
4	PRINT	On/off	Off	Start and stop of continuous printing. (If printer is switched off or not connected, this button is "Dimmed").
5	ALARM ▲	0 - 100 m	0 m	Shallow water alarm adjustment.
6	ALARM ▼	0 - 1600 m	100 m	Deep water alarm adjustment.

The currently selected transducer (frequency) is indicated at the bottom of all screens along with optional transducer position, e.g. 200 kHz/FWD. (DRT0.00 m and 200 kHz/FWD are toggling with 1 sec. interval.) Selection of the transducer position reference is performed in screen 10.

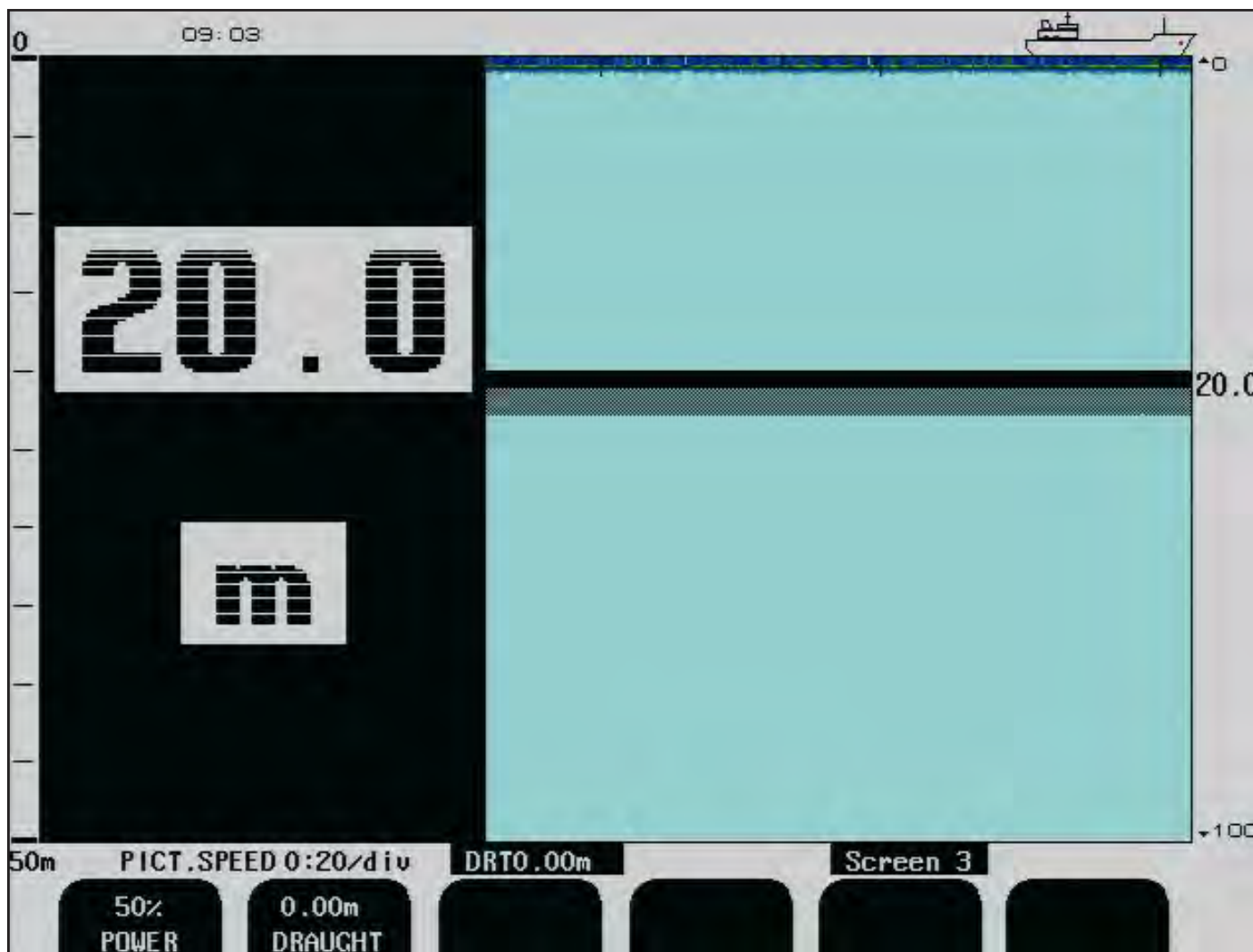


**Fig. 2.3. Screen 2, 2nd Operation screen.**

This screen shows the main graphic echo gram. Left hand digital indication may be enabled from this screen.

Soft key	Name	Range/value	Default value	Description
1	DIGITAL	Off, small, large	Off	Control of digital depth indication.
2	FREQUENCY	38*/50/200 kHz	50 kHz	Transducer selection. (Have to be “installed “ in screen 10, soft key 2 and 3)
3	MARK	Line		Print mark line/dump screen.
4	PRINT	On/off	Off	Start and stop of continuous printing.
5				Not used.
6	SYSTEM	On/off	On	Switch system off. Switch on with any button. (NOTE: There is still power on the GDS101).

\* **Note:** 38 kHz may vary if other options are installed.



**Fig. 2.4. Screen 3, 3rd Operation screen.**

This screen shows the main graphic echo gram. Left hand digital indication may be enabled from screen 2.

Soft key	Name	Range/value	Default value	Description
1	POWER	1 - 100 %	50 %	Transmitter power adjustment.
2	DRAUGHT	-99.99 - 99.9 m	0.00 m	Draught correction, must be set individually for each frequency.
3 (Option)	SOUND	1400 - 1550 m/s	1500 m/s	Sound speed setting, (option).
4 (Option)	AUTORANGE	On/off		Auto range control, (option).
5 (Option)	PING	Continuous, edge, level, single	Continuous	Ping control, (option).
6				Not used.

**Note:** Soft keys 3, 4 and 5 controls optional functions.

Secondary Operation Screens

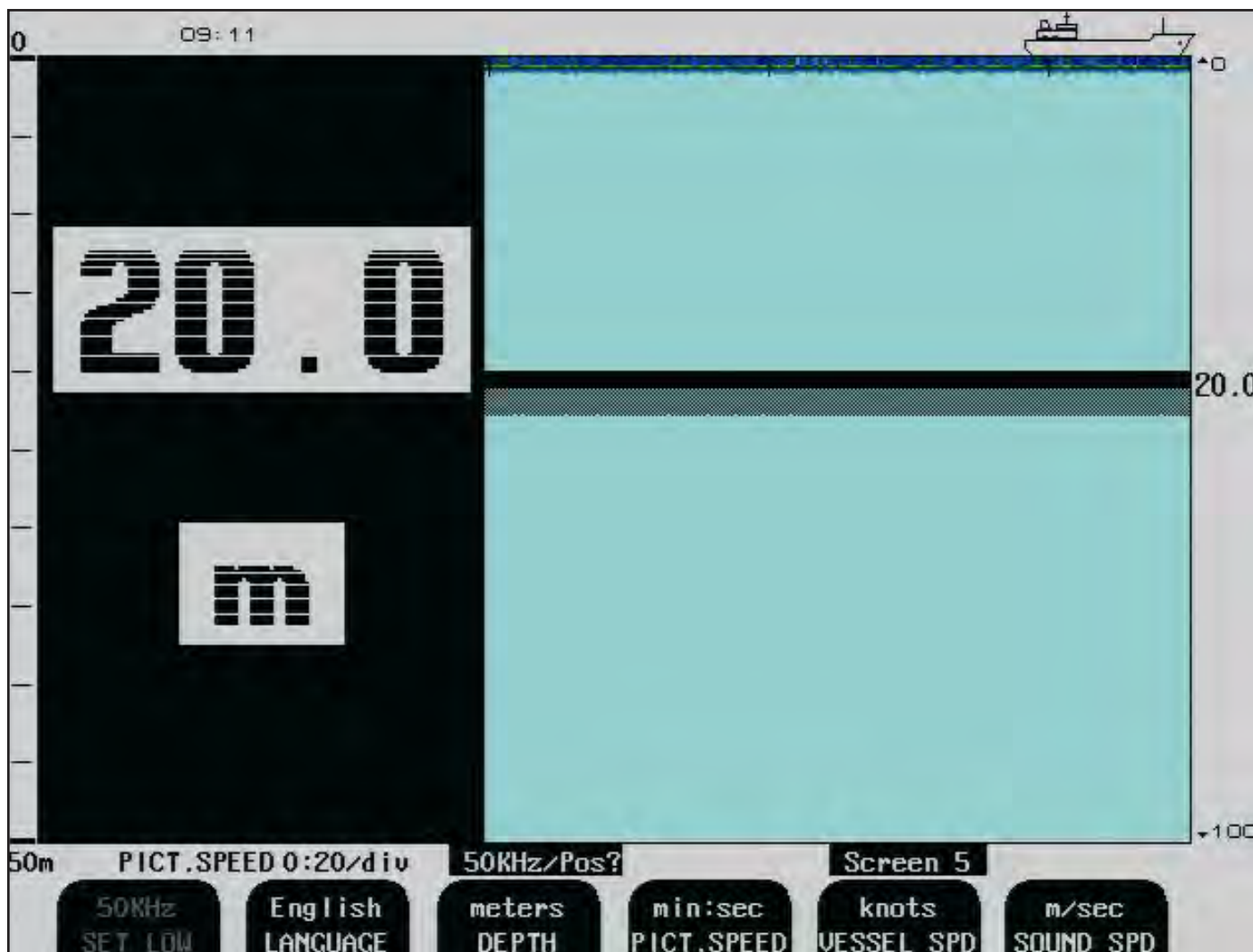


**Fig. 2.5. Screen 4, Calendar and clock setting.**

This screen shows the main graphic echo gram. Left hand digital indication may be enabled from screen 2.

Soft key	Name	Range/value	Default value	Description
1	PRINTER	Manual/auto	Manual	External printer start options. Auto: Printer start, if depth alarm is activated.
2				Not used.
3	Y(EA)R.MONTH	01.03 ->		Calendar year setting.
4	DAY	1 - 31		Calendar day setting.
5	HOURS	0 - 23		Real time clock hours setting.
6	MINUTES	0 - 59		Real time clock minutes setting.

**Note:** If GPS is connected, soft key 3, 4, 5 and 6 are controlled by GPS.

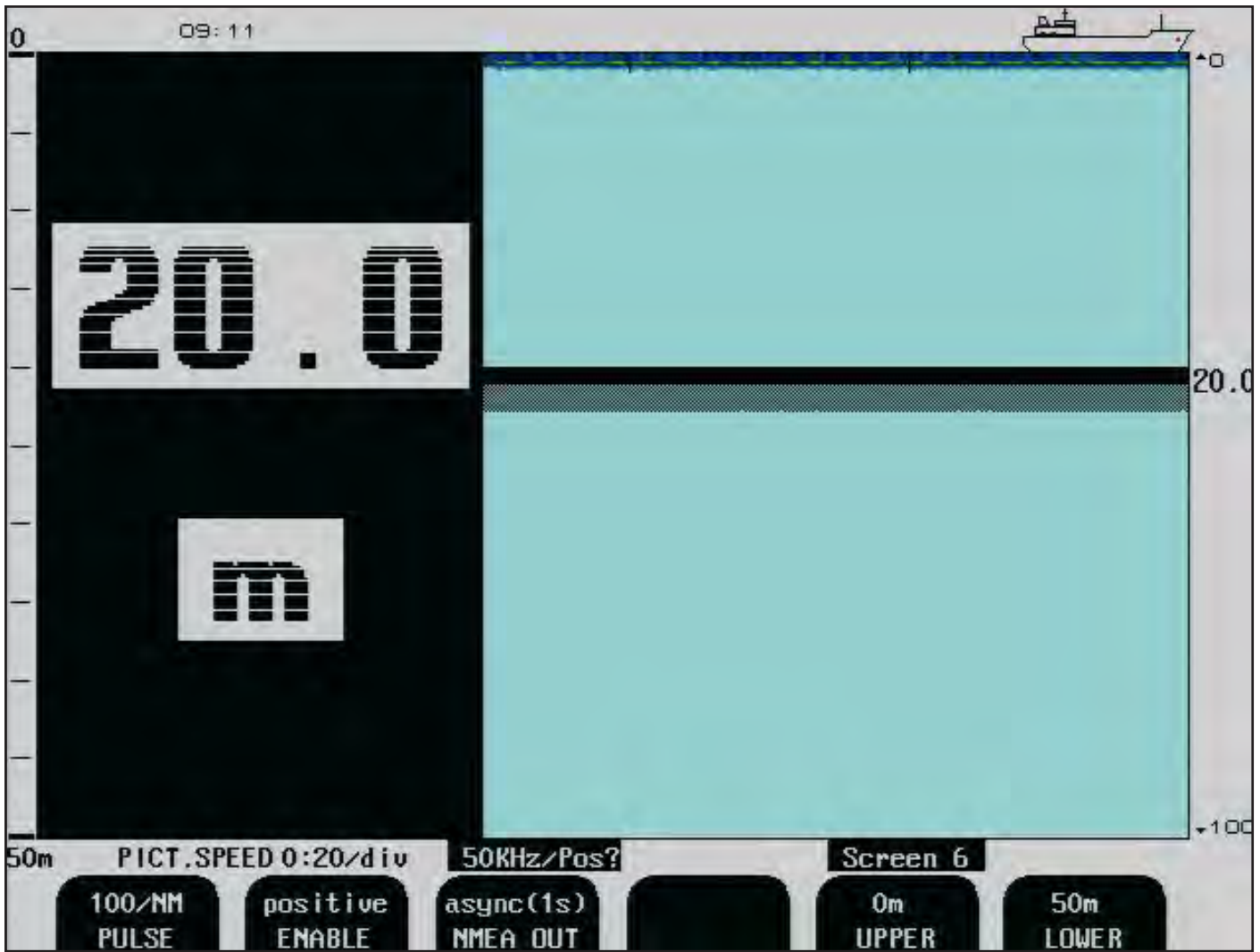


**Fig. 2.6. Screen 5, Language and units of measure setup.**

This screen shows the main graphic echo gram. Left hand digital indication may be enabled from screen 2.

Soft key	Name	Range/value	Default value	Description
1	SET LOW	24, 28, 30, 33, 38 kHz		Adjust indicated frequency of lower frequency channel. (See chapter 5, low frequency indication).
2	LANGUAGE	English, French, Spanish, Russian, German, Norwegian	English	Screen language selection.
3	DEPTH	Meters, feet, fathoms, braccias	Meters	Unit of measurement for depth.
4	PICT.SPEED	Min:sec	Min:sec	Unit of measurement for picture speed.
5	VESSEL SPD	Knots, km/h, mi/h	Knots	Unit of measurement for vessel speed.
6	SOUND SPD	m/sec, ft/sec	m/sec	Unit of measurement for sound speed.

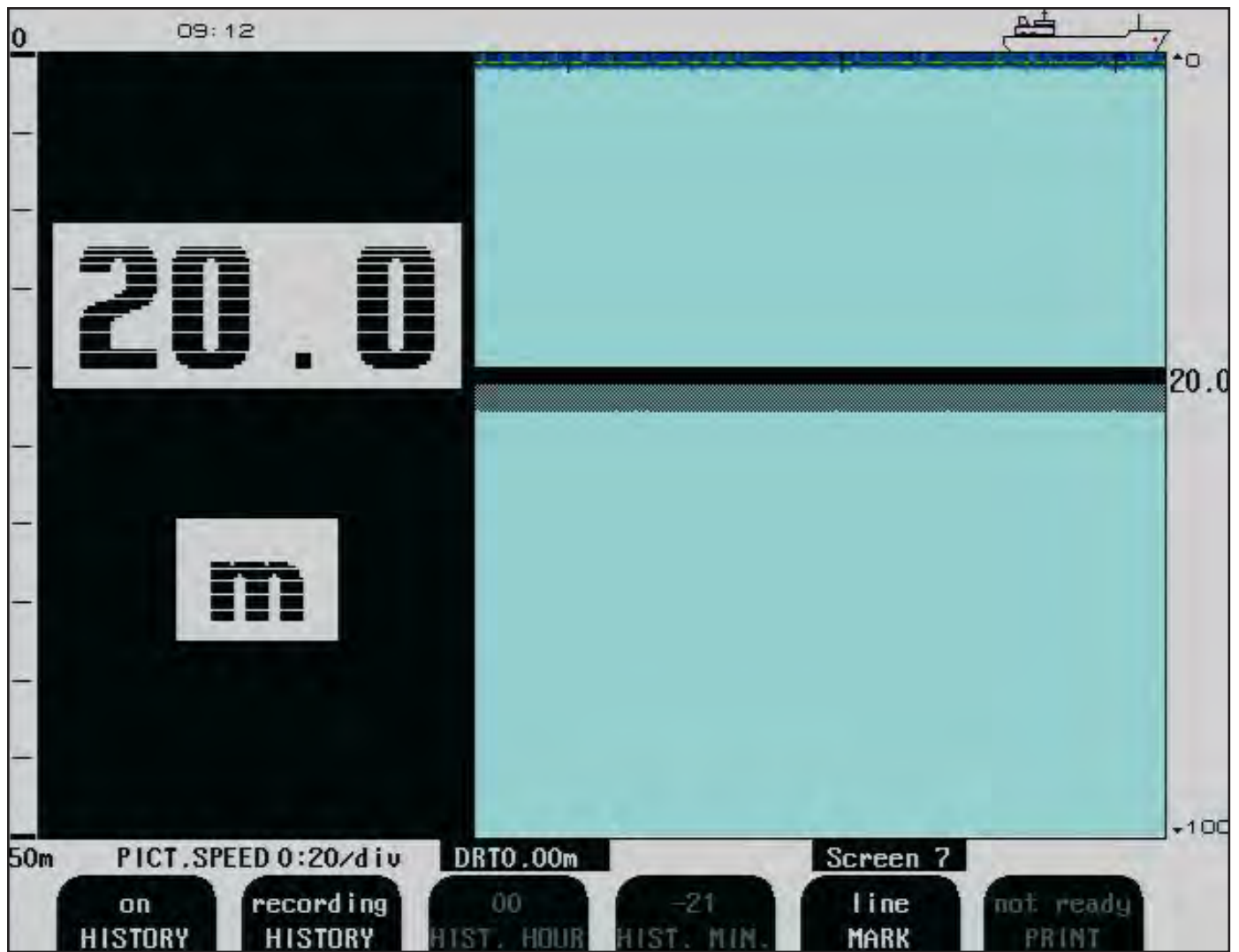




**Fig. 2.7. Screen 6, Interface setup screen.**

This screen shows the main graphic echo gram. Left hand digital indication may be enabled from screen 2.

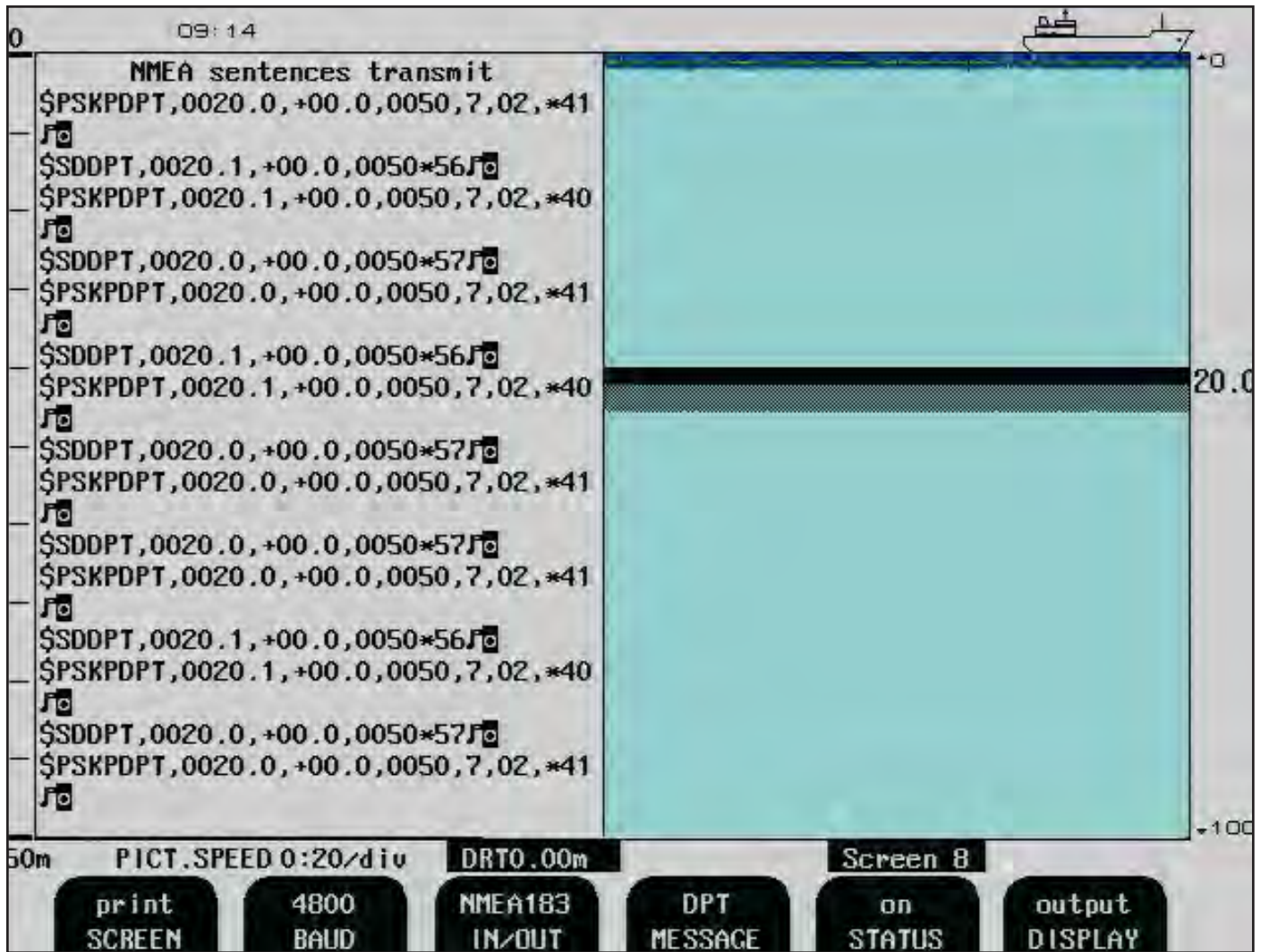
Soft key	Name	Range/value	Default value	Description
1	PULSE	100/200/400/20000	100/NM	Speed log input pulse rate.
2	ENABLE	Positive/negative	Positive	Select polarity of external sync signal (remote sounding control option).
3	NMEA OUT	async (1s)/ (sync)hronous	async (1s)	Select between synchronous (with sampling rate) and asynchronous (1s period) NMEA output update.
4				Not used.
5	UPPER	0 - 99 m	0 m	Analogue output shallow water limit = 0 V (4 mA).
6	LOWER	0 - 100 m	50 m	Analogue output deep water limit = 10 V (20 mA).



**Fig. 2.8. Screen 7, History Memory Control Screen.**

This screen shows the main graphic echo gram. Left hand digital indication may be enabled from screen 2.

Soft key	Name	Range/value	Default value	Description
1	HISTORY	On/off	On	Start/stop (keep) history recording.
2	HISTORY	Recording/playback	Recording	Record/playback of history.
3	HIST. HOUR	-23 - 0 hour		History playback spooling, hours.
4	HIST. MIN	-59 - 0 min		History playback spooling, minutes.
5	MARK	Line		Print mark line/dump screen.
6	PRINT	(Not ready)/On/off	Off	Start and stop of continuous printing.



**Fig. 2.9. Screen 8, NMEA control screen.**

This screen shows list of received or transmitted NMEA messages and half screen echo gram.

Soft key	Name	Range/value	Default value	Description
1	SCREEN	Print		Print screen.
2	BAUD	4800/9600	4800	NMEA baud rate selection
3	IN/OUT	NMEA 0183/RS-232	NMEA 0183	I/O port selection
4	MESSAGE	DPT, DBS, DBT, DBK, PSKPDPT, CHECK SUM, EN250, EN250#, XDR	DPT: On DBS: Off DBT: Off DBK: Off PSKPDPT: Off CHECK SUM: On EN250: Off EN250#: Off XDR: Off	Select if message should be on/off by soft key 5. CHECKSUM, select if PSKPDPT should contain checksum or not by soft key 5.
5	STATUS	On/off		Select if MESSAGE should have on or off status.
6	DISPLAY	Off/input/output	Input	Selects what kind of information to be displayed. <b>Off:</b> None. <b>Input:</b> Received NMEA messages. <b>Output:</b> Transmitted NMEA messages.

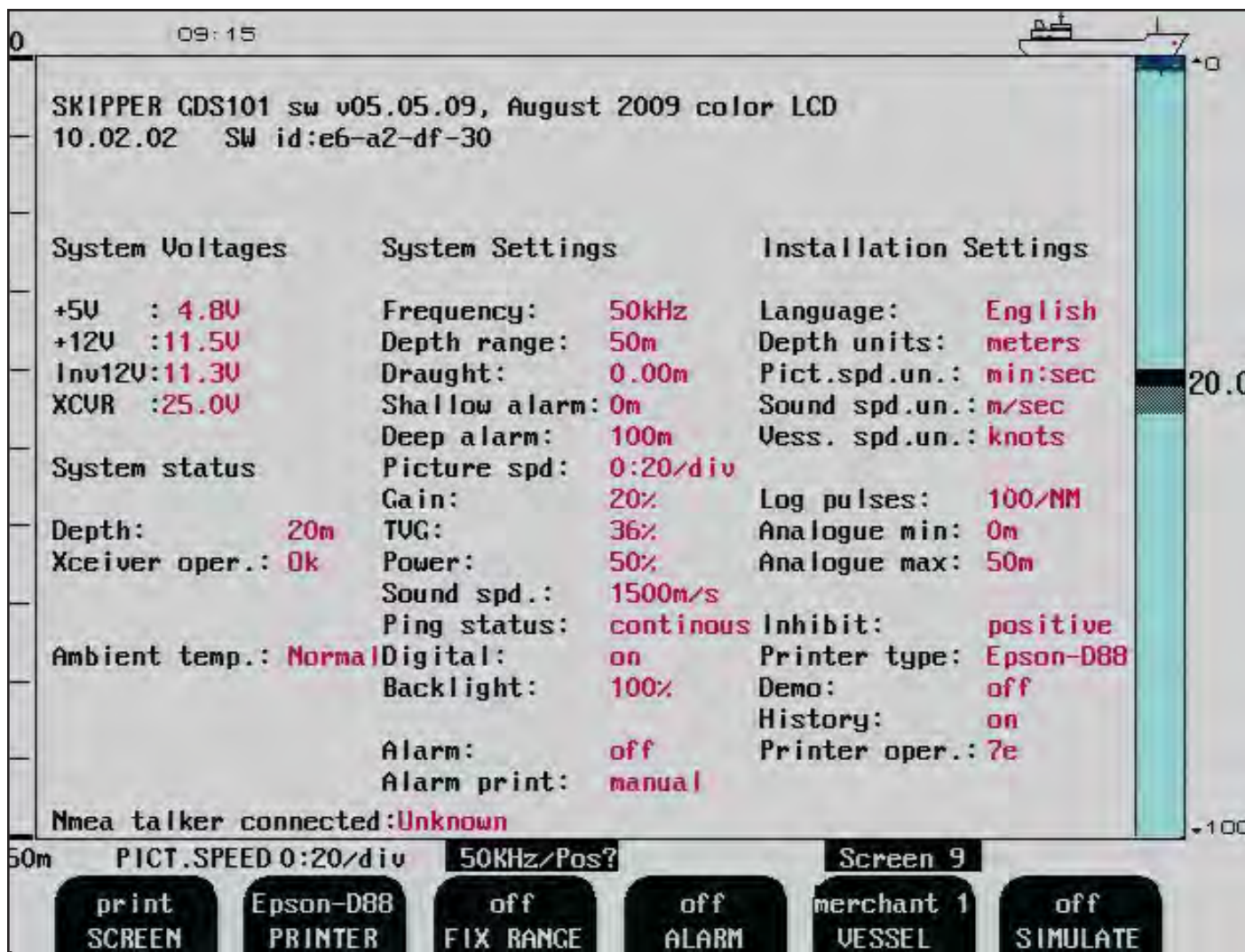
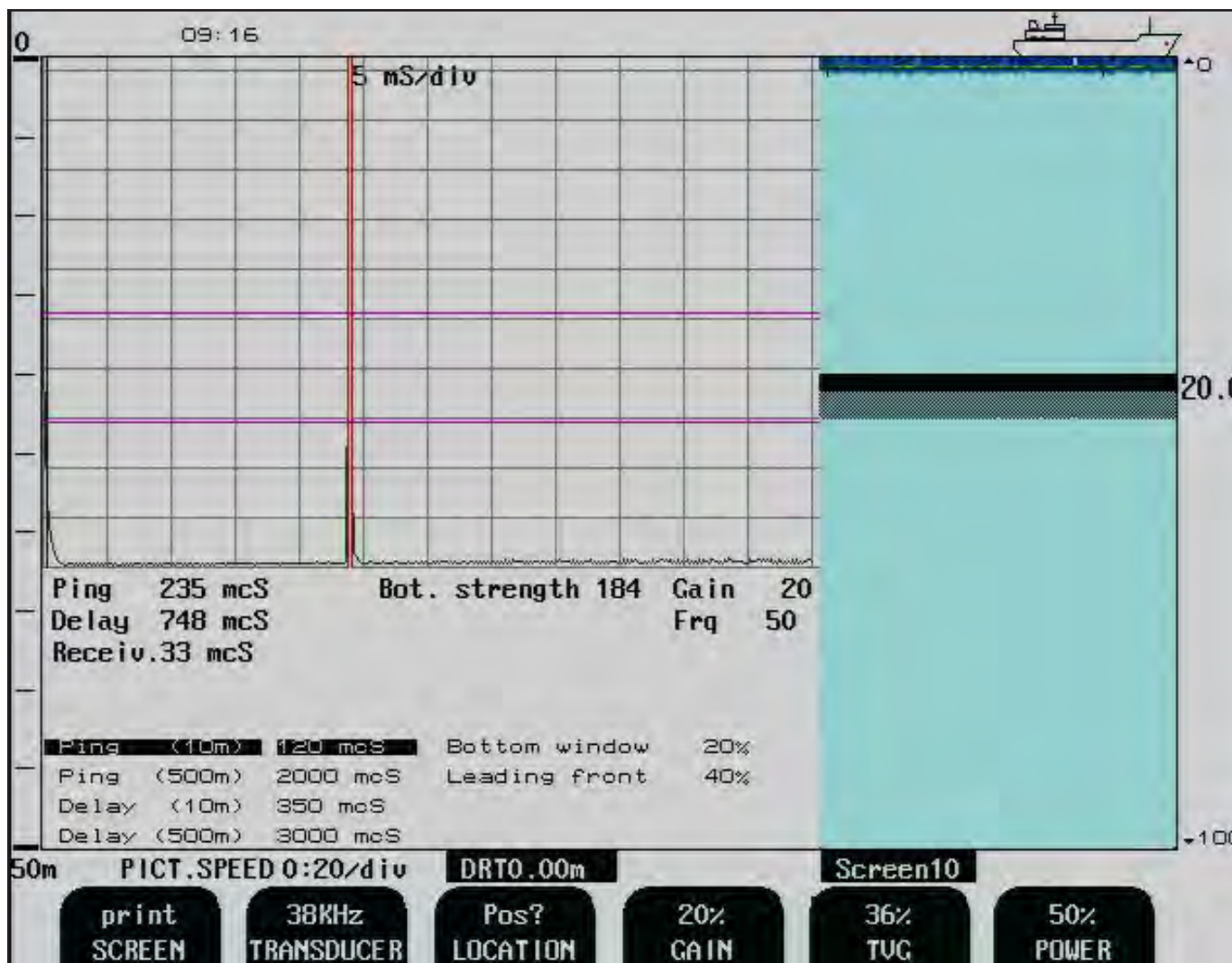


Fig. 2.10. Screen 9, System status screen.

This screen shows a comprehensive list of system settings and parameters

Soft key	Name	Range/value	Default value	Description
1	SCREEN	Print		Print screen.
2	PRINTER	HP DeskJet/Epson (LQ300+) /Epson-D88/Built-in printer.	Epson-D88	Select type of printer that is connected.
3	FIX RANGE	On/off	Off	Limit search range to window. FIX RANGE “on” gives better detection in case of noisy signal.
4	ALARM	On/off	Off	Internal alarm buzzer control.
5	VESSEL	Merchant 1/2, Navy 1/2	Merchant 1	Upper right screen icon selection.
6	SIMULATE	On/off	Off	Built-in simulator control.



**Fig. 2.11. Screen 10, Oscilloscope screen.**

This screen shows receiver output versus time and half screen echo-gram.

Soft key	Name	Range/value	Default value	Description
1	SCREEN	Print		Print screen.
2	TRANSDUCER	38, 50, 200 kHz	38 kHz	Transducer selection for soft key 3.
3	LOCATION	Pos? Not installed, FWD, AFT, PORT, STRB, FWD/AFT, PORT/STRB,	Pos?	If “not installed” is selected for one of the frequencies, it will not be available in screen 2, soft key 2. 2 transducers with transducer selector (ENS518). See chapter 5, remote transducer selector and NMEA sentences.
4	GAIN	0 - 100 %	20 %	Gain adjustment.
5	TVG	0 - 100 %	36 %	Time Variable Gain adjustment.
6	POWER	1 - 100 %	50 %	Transmitter power adjustment.

## Principal Functions

### Bottom detection

GDS101 employ a bottom detection algorithm that will try to extract the bottom signal from all kinds of noise and secondary echoes. When GDS101 is tracking the bottom normally, a thick black line is shown, and below that, a ribbon with a hatched pattern. This pattern has two levels of hatching. The darkest represent strong and unambiguous bottom echoes. The lighter hatching represents weaker signals possibly occasional detection misses. If the software can detect no bottom for several pings, the hatched ribbon disappears.

During normal bottom tracking, a digital value is shown by the bottom contour at the right side of the screen. If the software algorithm loses track of the bottom altogether, a warning beep is heard and the black line and hatching band disappears. A warning message: "Lost bottom" is shown in the screen's lower right corner.

### Ping to Ping filtering

Part of the bottom detection algorithm is the ping to ping filtering. The next bottom is searched for in a time and strength window based on the strength and timing of the previous bottom echoes. This procedure reduces the probability of tracking schools of fish or secondary echoes as bottom. If no bottom is detected in the calculated window, the window is gradually increased in size until the full time and strength window is used.

### Bottom Search Range

The FIX RANGE function in screen 9 is used to control the search range for the bottom detection algorithm. When this function is on, bottom is only searched for within the selected display range. When the function is off, bottom is searched for within the entire functional range of the echo sounder.

### System (Power) On/Off

During normal daily operation, the system may be switched off from screen 2. This operation does not disconnect the system from the power supply, but all power consuming components are switched off. The system may be switched on again by pressing any button.

### Note:

**Do not run the sounder for a long time without a submerged transducer connected.**

### Alarm acknowledgement

When the water depth alarm is activated, the alarm may be acknowledged by pressing any button.

## Fixed Key Functions

### Depth Range

The DEPTH RANGE button can be used to set the depth limit between 10 and 1600 m. Standard values available by repeatedly pressing the button are 10, 50, 100, 500 and 1000 m.

### Picture Speed

Picture speed may be referred to either time or vessel speed. If no speed log is connected, picture speed will always be referred to time, (“min:sec/div”). Time referenced picture speed may be selected between 20 seconds per division and 5 minutes per division. Vessel speed referenced picture speed may be selected between 0.04 and 5 nm per division. If a speed log is connected, it is possible to select different “PICT.SPEED” units in screen 5. The ping-rate range depends on the depth range, and the fastest ping rate at shallow depths is about 5 pings per second.

### Screen Select

The SCREEN SELECT button facilitates selection of one of the 10 screen and soft key layouts. The 3 primary operation screens may be cycled by repeatedly pressing the SCREEN SELECT button. Access to the remaining screens is through encoder operation. The screens are cycled in an endless, bidirectional loop, e.g. turning the encoder counter-clockwise, will activate screen 10 after screen 1. Turning the encoder with no buttons pressed always force screen 1.

### Day/Night and back light adjustment

Day/Night vision may be selected by pressing this button. These two modes differs by colour presentation, which are optimized for different ambient light conditions.

## Soft Key Functions

### Gain

The received signal gain may be adjusted from 0 to 100 % to allow for optimal echo levels from bottom and other objects. The gain setting affects signals from all depths.

### TVG

Time Variable Gain may be adjusted from 0 to 100 % to allow for detailed echo control from the 0 - 50 m depth range. A low setting will reduce the gain in the area near the surface to suppress noise and unwanted echoes from this area.

### Digital indication

On the operation screens, two sizes of large digital depth indicators may be selected from screen 2.

1. "Small" digits.
2. "Large" digits.

### Frequency

The frequency selector toggles among 38\*, 50 and 200 kHz.

\* Some units may have been adjusted to other frequencies.

### Output Power

Power may be adjusted from 1 to 100 % in case of difficult shallow water conditions. Too high power in such cases will possibly saturate the receiver or cause detection of unwanted secondary bottom or surface echoes.

### Draught

Draught may be compensated to allow real depth from surface to be shown on the screen and printout. Negative draught values may be entered to compensate for transducers fitted above the keel. This setting also affects the NMEA transmitted values. Draught value is indicated on the lower part of the screen by a flashing/alternating number.

### External Printer Operation

The optional external printer is started and stopped by the PRINT button in screen 1. The printer may be used for continuous printing over a period of time or the current screen contents may be dumped to the printer for reference if something interesting is observed.

- The PRINT button switches continuous printing on and off.
- The MARK button(s) will write a line mark on the paper if it is pressed whenever the printer is running.
- If the MARK button is pressed when the printer is online, this will initiate a screen dump of the present screen contents. If printer is switched off, or not connected, the PRINT button is "dimmed".



## Alarm Settings

Water depth alarm settings are performed from screen 1. Alarm limits are referred to the indicated depth. The local alarm buzzer may be disabled from screen 9, but the external alarm relay will always operate. The only way to disable the alarms completely, is to reduce the shallow water alarm to zero depth and increase the deep water alarm to maximum range. An active shallow water alarm limit must be less than an active deep water alarm limit. Alarm limits are enforced with hysteresis. A depth alarm may automatically start the optional printer, if this function is enabled on screen 4.

## Clock and Calendar Settings

Manual clock and calendar adjustments are carried out in screen 4. If a satellite navigator giving UTC messages is connected to the NMEA input, the clock and calendar will be automatically updated and manual adjustment is not required.

## History Memory

GDS101 has a 24 hour history memory. Depth, time and all available navigation data are stored continuously, so that the last 24 hours of information is always available. The history memory is controlled from screen 7.

The normal history modes are “on” and “recording”. New depth information is continuously stored in the memory while the oldest samples are discarded. Only bottom information is stored along with time and whatever navigational information is available in the GDS101 (position, speed, heading).

By switching HISTORY off, the stored 24 hours will be kept in the memory and no new samples will be recorded. As a warning that the memory is not recording, “HISTORY off” is flashing at the bottom of the screen.

History modes “on” and “playback” will start playing the contents of the history memory on the screen and on the optional printer, if it is running. As a warning that the displayed bottom contour is from the memory and not real time, “HISTORY” is flashing at the bottom of the screen.

The HIST HOURS and HIST MINUTES buttons used with the encoder, will enable positioning within the 24 hour memory to observe the desired part of the time frame during playback.

## **Simulator**

The GDS101 contains a built in simulator to test the screen and various interface signals. The simulator may be switched on and off on screen 9. When the simulator is operating, "DEMO" is flashing at the bottom of the screen.

## **Status Screen**

The status screen, screen 9 shows a list of various system parameters useful for documenting system setup and operating status. The contents of this screen will be valuable information in situations where manufacturer support is required.

## **Oscilloscope Screen**

The oscilloscope screen, screen10 is useful when monitoring transceiver performance. The oscillogram shows the signal returned from the transceiver plotted against time and will enable service personnel to evaluate system performance and facilitate any troubleshooting.

## **Nonvolatile Parameter Memory**

The system contains internal flash memory to maintain installation and user parameters like language and unit of measurement selection, contrast and backlight settings, etc. These parameters are automatically restored on power up. If the user parameters have never been set, default values are used.

# **Options**

## **Repeaters/Slaves**

Graphic display or digital depth slave repeaters may be connected to the system. Along with the graphic display repeaters, there may also be installed a remote keyboard.

## **Remote Sounding Control**

This option lets the GDS101 being controlled remotely in synchronized (edge), burst (level) or single ping modes. If installed, this option is accessible on screen 3. (**Note:** Non Wheelmark model).

## **Auto Range**

This option will automatically adjust the depth range to maintain the bottom contour within the middle part of the screen height. If installed, this option is accessible on screen 3. When the optional printer is started, auto range is automatically disabled, and the present depth range is selected as fixed.

## **Sound speed calibration**

This option will enable adjustment of the sound speed value used for the depth calculations. The standard value is 1500 m/s, but the user may set values from 1400 to 1550 m/s to accommodate accurate propagation speed in known water conditions. If installed, this option is accessible on screen 3. (**Note:** Non Wheelmark model).

## **External Printer**

Printer for endless paper or inkjet printer for single sheets (ask SKIPPER for actual type) may be connected for hardcopy requirements.

### **3. User Maintenance**

---

#### **Transducer Maintenance**

The transducers are virtually maintenance free, but occasional cleaning may be necessary depending on sea water conditions.

#### **Operator Unit Maintenance**

The operator unit contains no user serviceable parts, and requires no maintenance apart from occasional cleaning of the front panel. Please use a soft cloth and no chemicals except cleaning alcohol.

**Note:** In normal useage, the system should show satisfactory results with the following settings:

- Gain = 20 % (Not auto).
- TVG = 36 %.

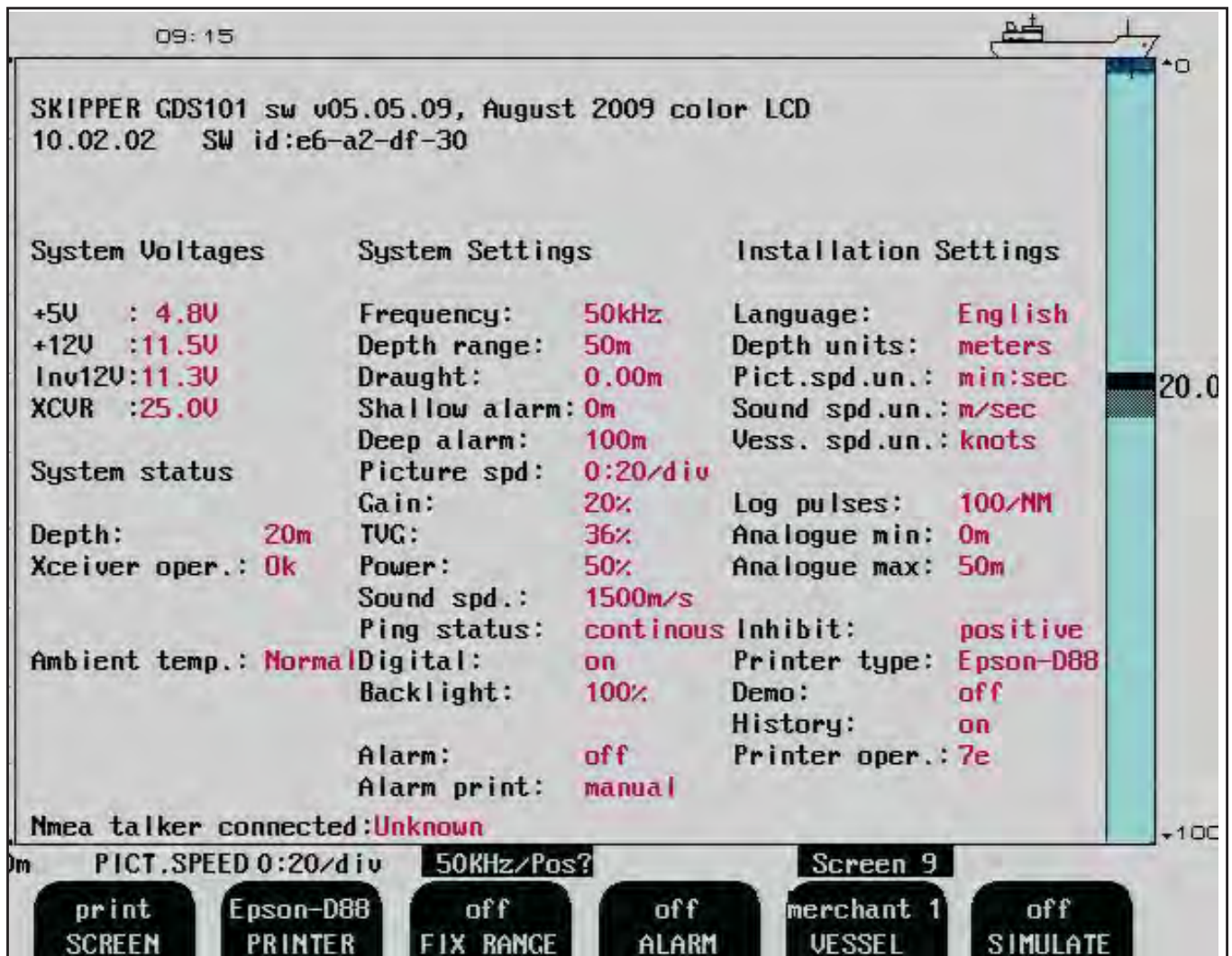
Always try to return to these settings before continuing.

Please also try a “Master Reset”, see chapter 8 for more details.

### Trouble Shooting

Symptom	Cause	Remedy
<b>Basic System Integrity</b>		
<ul style="list-style-type: none"> <li>• No picture on LCD screen.</li> </ul>	<ol style="list-style-type: none"> <li>1. No AC or DC power to the system.</li> <li>2. System is in standby.</li> <li>3. Too low screen backlight.</li> <li>4. Defective LCD module or interface.</li> <li>5. Voltage(s) out of range.</li> <li>6. System rebooted too quickly.</li> </ol>	<ol style="list-style-type: none"> <li>1. Check switches and fuses on the terminal board inside the GDS101 cabinet.</li> <li>2. Press any button on panel.</li> <li>3. Increase backlight setting, change to day vision.</li> <li>4. Replace module or backlight inverter PCB.</li> <li>5. Replace terminal PCB.</li> <li>6. Turn off powerswitch(es) - wait a few sec, restart.</li> </ol>
<ul style="list-style-type: none"> <li>• Picture is difficult to read.</li> </ul>	<ol style="list-style-type: none"> <li>1. Backlight is too weak.</li> <li>2. Night vision is on during day time.</li> </ol>	<ol style="list-style-type: none"> <li>1. Increase backlight setting.</li> <li>2. Increase backlight setting, or change to day vision.</li> </ol>
<ul style="list-style-type: none"> <li>• Display backlight malfunctions.</li> <li>• Display picture is hardly visible.</li> </ul>	<ol style="list-style-type: none"> <li>1. Defective backlight tubes.</li> <li>2. Defective backlight inverter.</li> </ol>	<ol style="list-style-type: none"> <li>1. Replace tube assembly.</li> <li>2. Replace keyboard PCB.</li> <li>3. Replace backlight inverter PCB.</li> </ol>
<ul style="list-style-type: none"> <li>• Rotary encoder malfunctions.</li> </ul>	<ol style="list-style-type: none"> <li>1. Defective encoder or interface.</li> <li>2. Cabling error.</li> </ol>	<ol style="list-style-type: none"> <li>1. Replace keyboard PCB or terminal PCB.</li> <li>2. Check cabling to IO board J101 at both ends. (No cable on J103).</li> </ol>
<ul style="list-style-type: none"> <li>• Panel buttons malfunctions.</li> </ul>	<ol style="list-style-type: none"> <li>1. Defective buttons or interface.</li> <li>2. One button stuck.</li> </ol>	<ol style="list-style-type: none"> <li>1. Replace keyboard PCB or terminal PCB.</li> <li>2. Check key switches or replace keyboard PCB.</li> </ol>

## Typical Status Screen (9) Contents



The status screen (9) contains information that will facilitate analysis and correction of several problems. A printout of the status and oscilloscope screens should be sent by fax/E-mail with any report about functional disturbance. This will greatly facilitate remote failure analysis.

If it at all is possible to cycle through the screens and observe this information, several assumptions may be made regarding operation of the GDS101 system. Although some of the subsystems necessary for this basic system operation may still suffer from minor or intermittent operation disorders, the fact that it is possible to select and observe this screen, indicates correct operation of the following GDS101 subsystems:

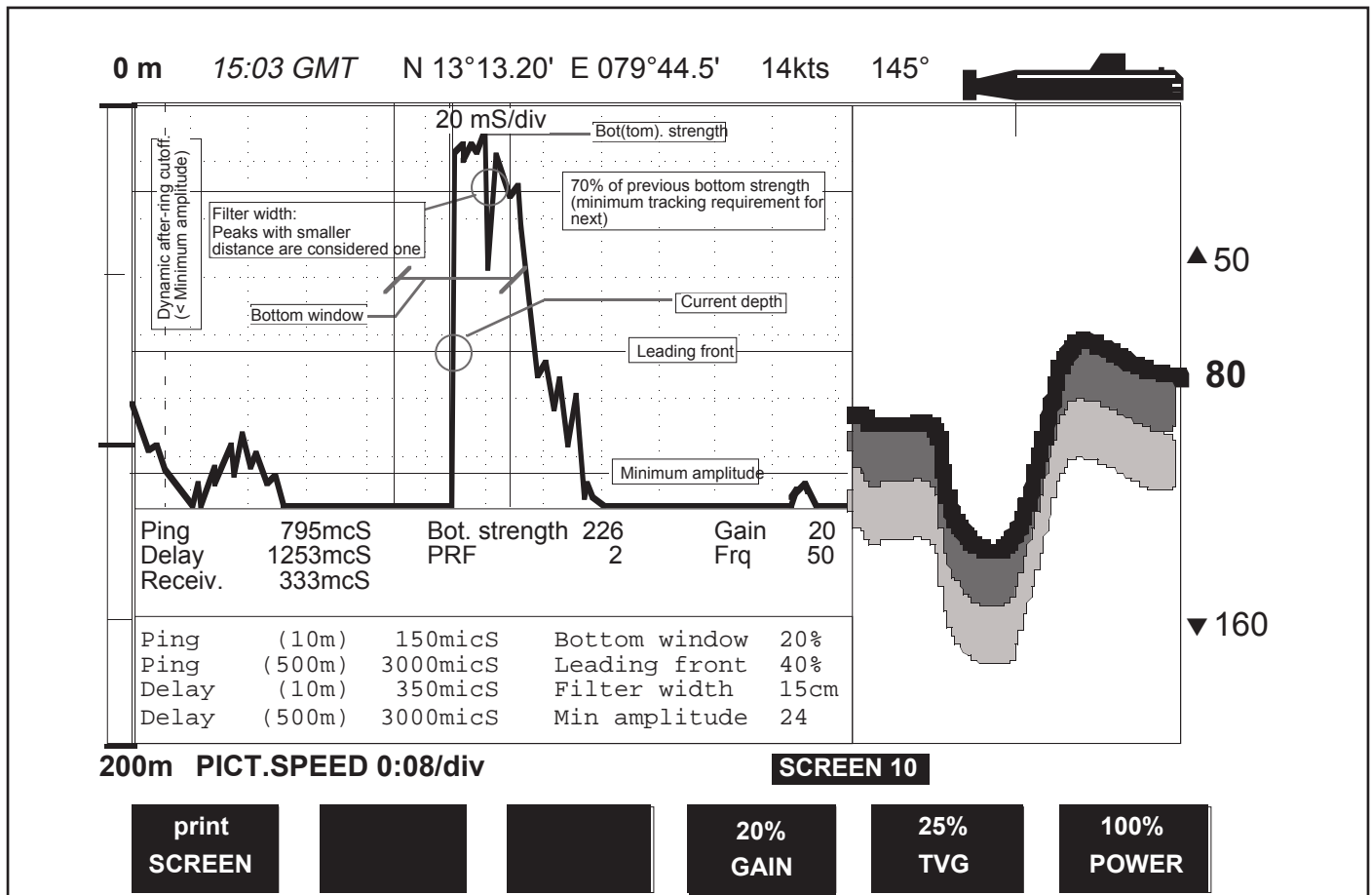
- The CPU board is operating.
- The keyboard interface board is working.
- The keyboard interface part of the I/O board is working.
- The power supplies on the terminal board are basically working.

**Note:** XCVR is linked to Power max (100 % = 40 - 48 V, 50 % = 22 - 25 V etc.). If the numbers are different, adjust your unit to the correct values and check if fault still occurs. Also ensure fix range is off and gain is not set to auto.

Symptom	Cause	Remedy
<b>Status screen diagnosis</b>		
Main voltages out of range <ul style="list-style-type: none"> <li>+ 5 V: <math>\triangleleft</math> 4.50 - 5.00 V</li> <li>+ 12V: <math>\triangleleft</math> 11.00 - 12.00 V</li> <li>Inv 12 V: <math>\triangleleft</math> 11.00 - 12.00 V</li> </ul>	<ul style="list-style-type: none"> <li>Defective power supply.</li> <li>Power supply overload.</li> </ul>	<ul style="list-style-type: none"> <li>Replace terminal board.</li> <li>+5 V: Computer or I/O board problem.</li> <li>+12 V: Transceiver problem.</li> </ul>
<ul style="list-style-type: none"> <li>Lost bottom, transceiver (XCVR) voltage low.</li> </ul>	<ul style="list-style-type: none"> <li>Power setting too low.</li> </ul>	<ul style="list-style-type: none"> <li>Increase power setting.</li> </ul>
<ul style="list-style-type: none"> <li>Lost bottom, Transceiver (XCVR) voltage <math>&lt;10</math> V when power is 50 % or 100 %.</li> </ul>	<ul style="list-style-type: none"> <li>Defective I/O card.</li> </ul>	<ul style="list-style-type: none"> <li>Replace I/O card, possibly terminal board.</li> </ul>
<ul style="list-style-type: none"> <li>System reboots intermittently.</li> </ul>	<ul style="list-style-type: none"> <li>Bus cable or motherboard error.</li> </ul>	<ul style="list-style-type: none"> <li>Temporary fix maybe to clean and reseal the motherbord connectors.</li> <li>Replace cable and/or card.</li> </ul>

The other information on the status screen is a collection of information which may be observed and manipulated with the various screen softkey selections. As a reference, it will often be more convenient to observe the various settings together on this screen than to cycle from screen to screen to check on the softkey texts.

### Typical Oscilloscope Screen (10) Contents



This oscilloscope screen 10 shows a typical oscillogram of a bottom echo (the tall peak in the centre of the diagram) and a weaker fish echo to the left of it. The horizontal axis represent time for the sound to travel down and back from an object. The vessel is located at the left edge of the grid, and the right edge represent the depth range. The vertical axis represent the magnitude of the echo signal received.

The length of the ping and the delay between pings, will adjust between preset limits (ping (10 m) and ping (500 m)). The actual length of these extremes are shown here.

Symptom	Cause	Remedy
<b>Basic Functionality</b>		
<ul style="list-style-type: none"> <li>No bottom detection or bottom contour.</li> </ul>	<ul style="list-style-type: none"> <li>Too low gain setting.</li> <li>Too low TVG setting.</li> <li>Too low power setting.</li> <li>Wrong frequency selection.</li> </ul>	<ul style="list-style-type: none"> <li>Adjust settings.</li> <li>Select correct frequency.</li> </ul>
<ul style="list-style-type: none"> <li>Bottom tracking is intermittent or erroneous.</li> </ul>	<ul style="list-style-type: none"> <li>Marginal gain, TVG or power settings.</li> <li>Weather conditions.</li> <li>Transducer installation faulty.</li> </ul>	<ul style="list-style-type: none"> <li>Adjust settings.</li> <li>Try adjust gain, TVG or power settings.</li> <li>Check transducer wiring, receiver LED on interface board or oscilloscope screen.</li> </ul>
<ul style="list-style-type: none"> <li>Bottom tracking is masked by high noise levels.</li> </ul>	<ul style="list-style-type: none"> <li>Too high gain setting.</li> <li>Too high TVG setting.</li> <li>Too high power setting.</li> </ul>	<ul style="list-style-type: none"> <li>Adjust settings.</li> </ul>
<b>Symptom Cause Remedy</b>		
<b>NMEA Interface etc.</b>		
<ul style="list-style-type: none"> <li>NMEA input signals are not listed in the NMEA screen.</li> </ul>	<ul style="list-style-type: none"> <li>Wrong polarity input signals.</li> </ul>	<ul style="list-style-type: none"> <li>Swap NMEA 0183 input wires.</li> </ul>
<ul style="list-style-type: none"> <li>NMEA input signals are listed in the NMEA screen, but not accepted by the GDS101.</li> </ul>	<ul style="list-style-type: none"> <li>GDS101 initialization.</li> <li>Irregular message mnemonic.</li> </ul>	<ul style="list-style-type: none"> <li>Cycle GDS101 power after NMEA connection is established.</li> </ul>
<ul style="list-style-type: none"> <li>NMEA signals are not accepted by the remote system.</li> </ul>	<ul style="list-style-type: none"> <li>Remote (listener) setup.</li> </ul>	<ul style="list-style-type: none"> <li>Verify correct remote (listener) setup.</li> </ul>
<ul style="list-style-type: none"> <li>Analogue output malfunctions.</li> </ul>	<ul style="list-style-type: none"> <li>Incorrect range setting.</li> </ul>	<ul style="list-style-type: none"> <li>Verify upper and lower limits in screen 6.</li> </ul>
<ul style="list-style-type: none"> <li>Pulse output malfunctions.</li> </ul>	<ul style="list-style-type: none"> <li>Incorrect pulse frequency setting.</li> </ul>	<ul style="list-style-type: none"> <li>Verify pulse settings in screen 6.</li> </ul>
<ul style="list-style-type: none"> <li>External control inputs malfunction, inhibit/ external printer control.</li> </ul>	<ul style="list-style-type: none"> <li>Incorrect polarity or function settings.</li> </ul>	<ul style="list-style-type: none"> <li>Verify settings in screen 6.</li> </ul>



## 4. Installation

### Standard System Supply

A basic GDS101 system consists of the following units. See fig. 4.1.

- Operator unit with installation material.
- Transducer junction box(es).
- Approved transducer steel tank(s) or Sea Valve(s).
- Transducer(s) and mounting.
- Operation and installation manual.

### Transducer Installation

#### Location

Single transducers are normally installed in the foreship. Larger vessels are often fitted with two transducers, one fore and one aft.

Optimal system operation is achieved by fitting the transducer as deep as possible on the hull. The transmitting surface of the transducer must be installed horizontal. On vessels with a deep keel, if the transducer must be fitted higher than the keel, it should be fitted towards the side, as far from the keel as possible to avoid false keel echo.

Do not mount transducers close to the propeller or aft of other hull installations (outlets, vents or other protruding details). It is necessary to select a part of the hull that is submerged under all load and speed conditions, and to avoid positions where air is trapped in heavy weather.

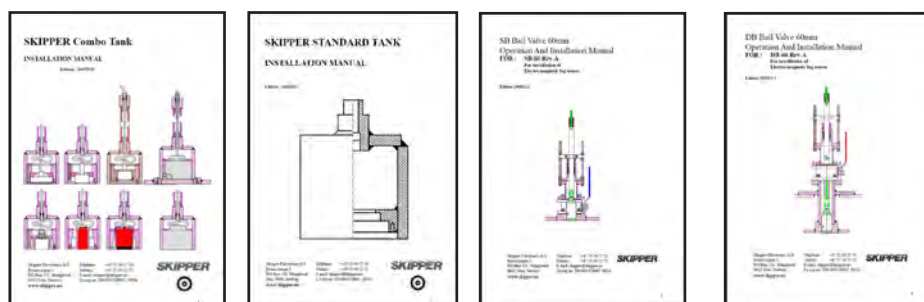
If a flat, horizontal section is not available for transducer fitting, the shipyard must construct a suitable bed.

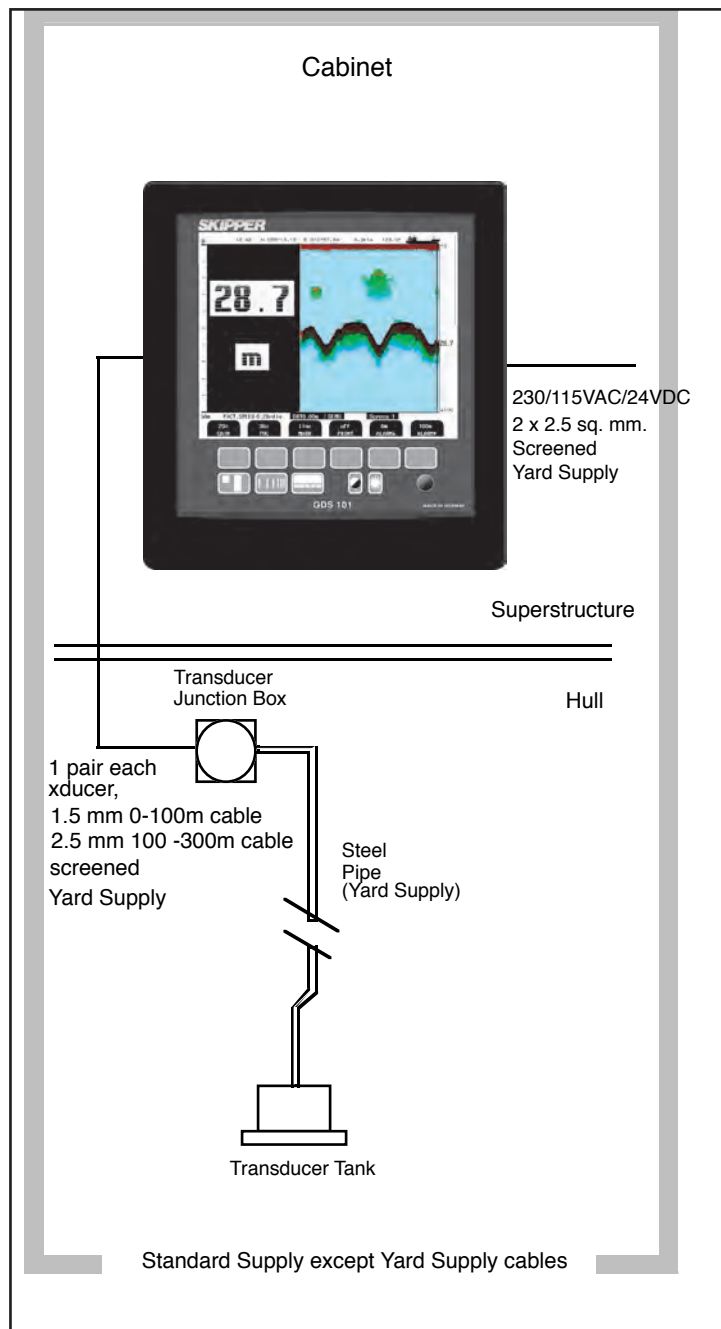
#### Note:

- Protect the active element of the transducer and do not paint the surface.
- Transmission in the air must be avoided! This may cause mechanical damage of the element.

#### Installation Details

Refer to SKIPPER's installation procedures in the appendix and on our web site [www.skipper.no](http://www.skipper.no) regarding information about Sea Valve, tank installation, welding, cable glands etc.





**Fig. 4.1. Basic System Configuration.**

### Transducer Junction Box

The standard cable fitted on the transducer is 25 m or 40 m and may be shortened. The junction box is used to interconnect the transducers fixed cable to a yard supply extension cable if the total required cable length is longer than the standard cable. It is recommended to run the standard cable in a steel protecting pipe. Special requirements apply in areas with explosive conditions. The junction box must always be mounted outside such areas.

Interconnect the transducer pair and its screen in the junction box, **but do not ground the screen here.**

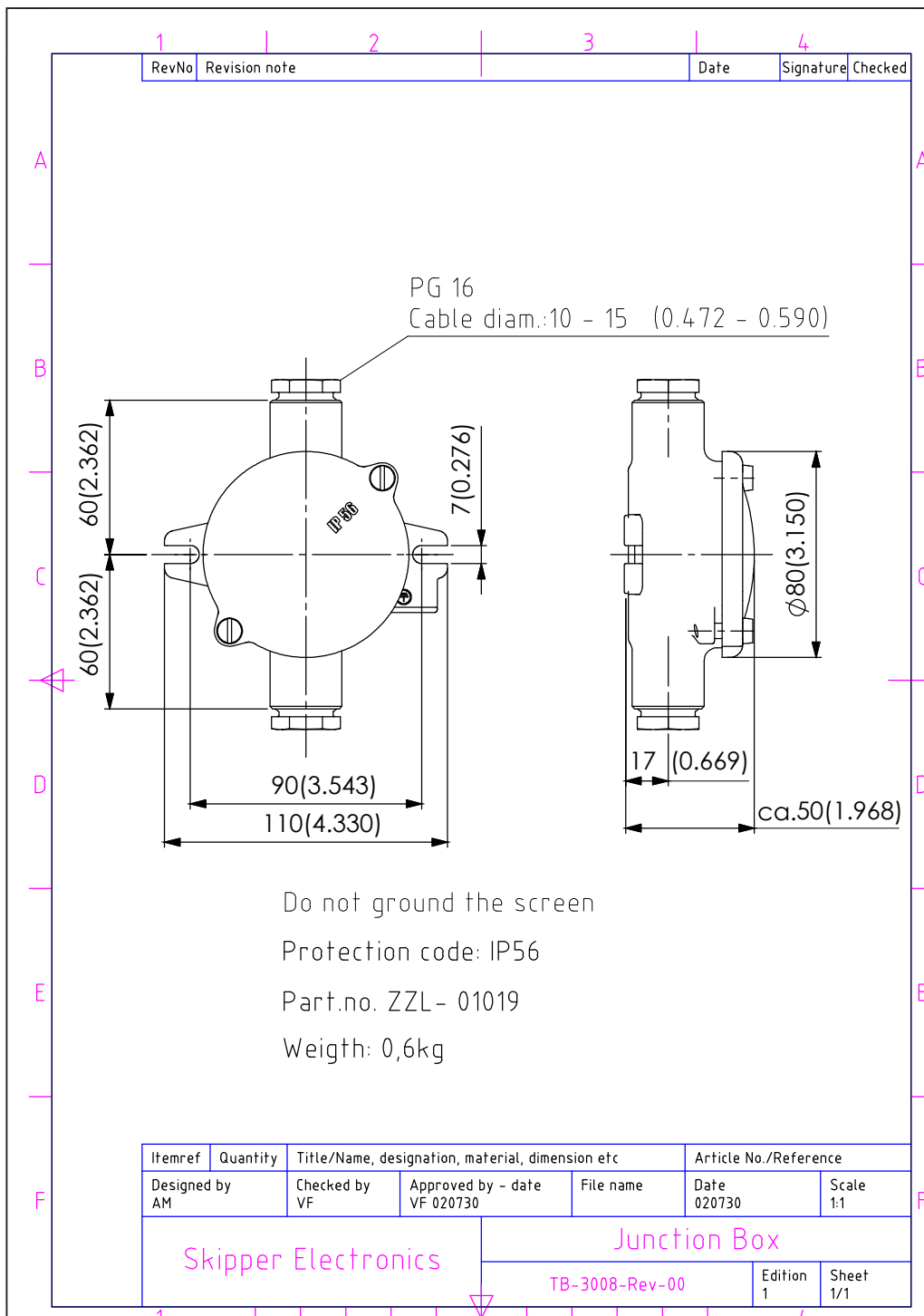


Fig. 4.2. Transducer Junction Box.

OPERATOR UNIT INSTALLATION

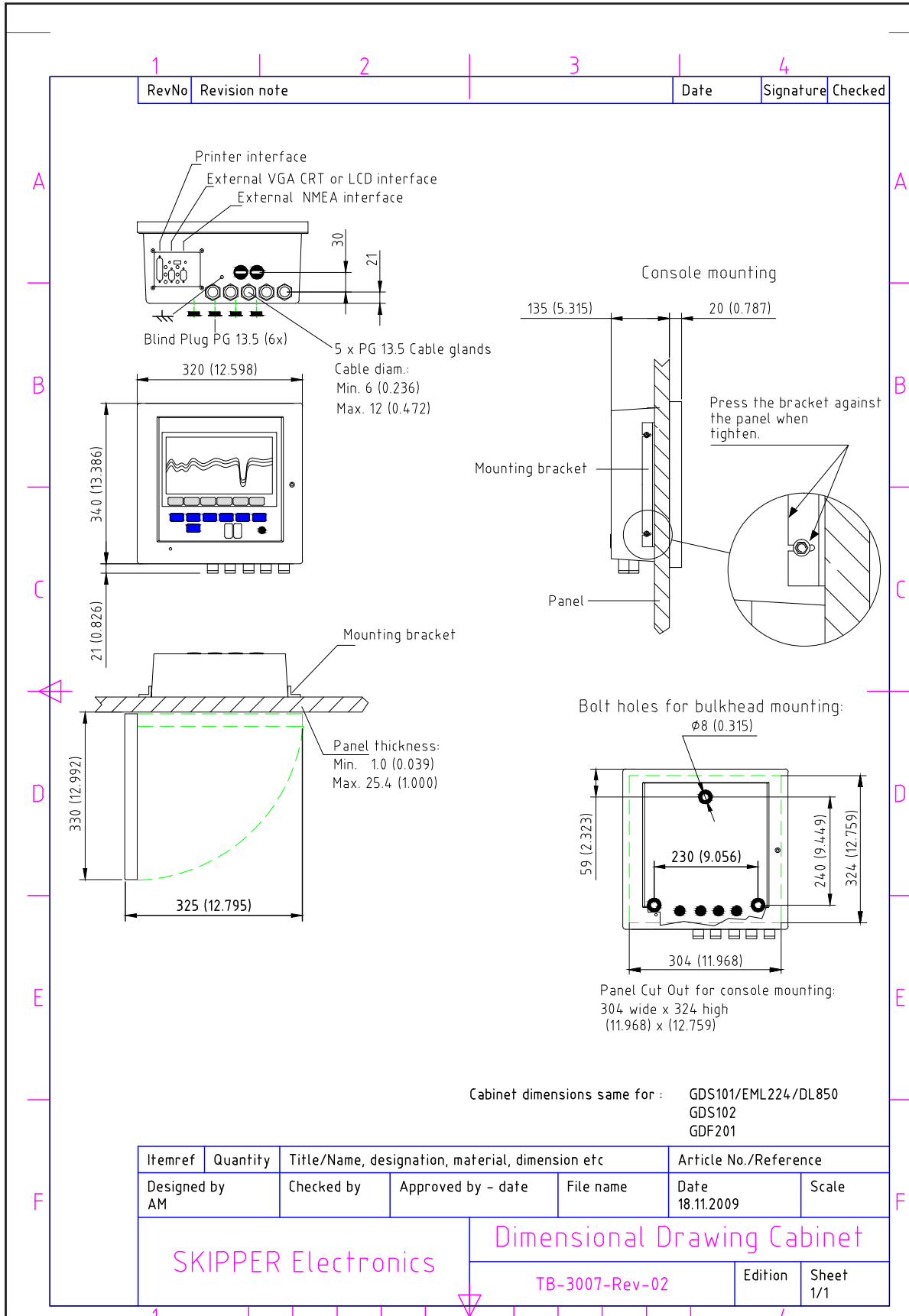


Fig 4.3. Operator Unit.

Select a position to provide free view of the panel as well as easy access during operation and service. The operator unit may be mounted flush in a panel or directly onto a bulkhead. Fig. 4.3 shows the operator unit along with the main installation dimensions. If the unit is to be flush mounted, the shown cut-out and recession depth dimensions must be observed.

Remember to leave room in front of the unit to open the door a full 90 degrees.

### **Do not perform installation work with system power applied!!**

Cables are led through the appropriate cable glands as follows:

- The cable from the transducer(s) should normally occupy the left gland.
- The right gland is used for power supply connection.
- The centre ones are used for any interface signals connected.

Power supply may be either 115/230 V AC or 24 V DC. Power consumption is app. 50 W at 24 V, app. 70W at 115/230 V.

The transducer is always connected with 1 pair plus screen. See fig 4.7.

If the AC power system is 115 V, GDS101 may be prepared for 115 V AC by re-connecting the connectors J102, J103 as shown in fig. 4.4.

This diagram also shows position of fuses for 115/230 V AC and 24 V DC. These fuses are normal 5 x 20 mm glass fuses.

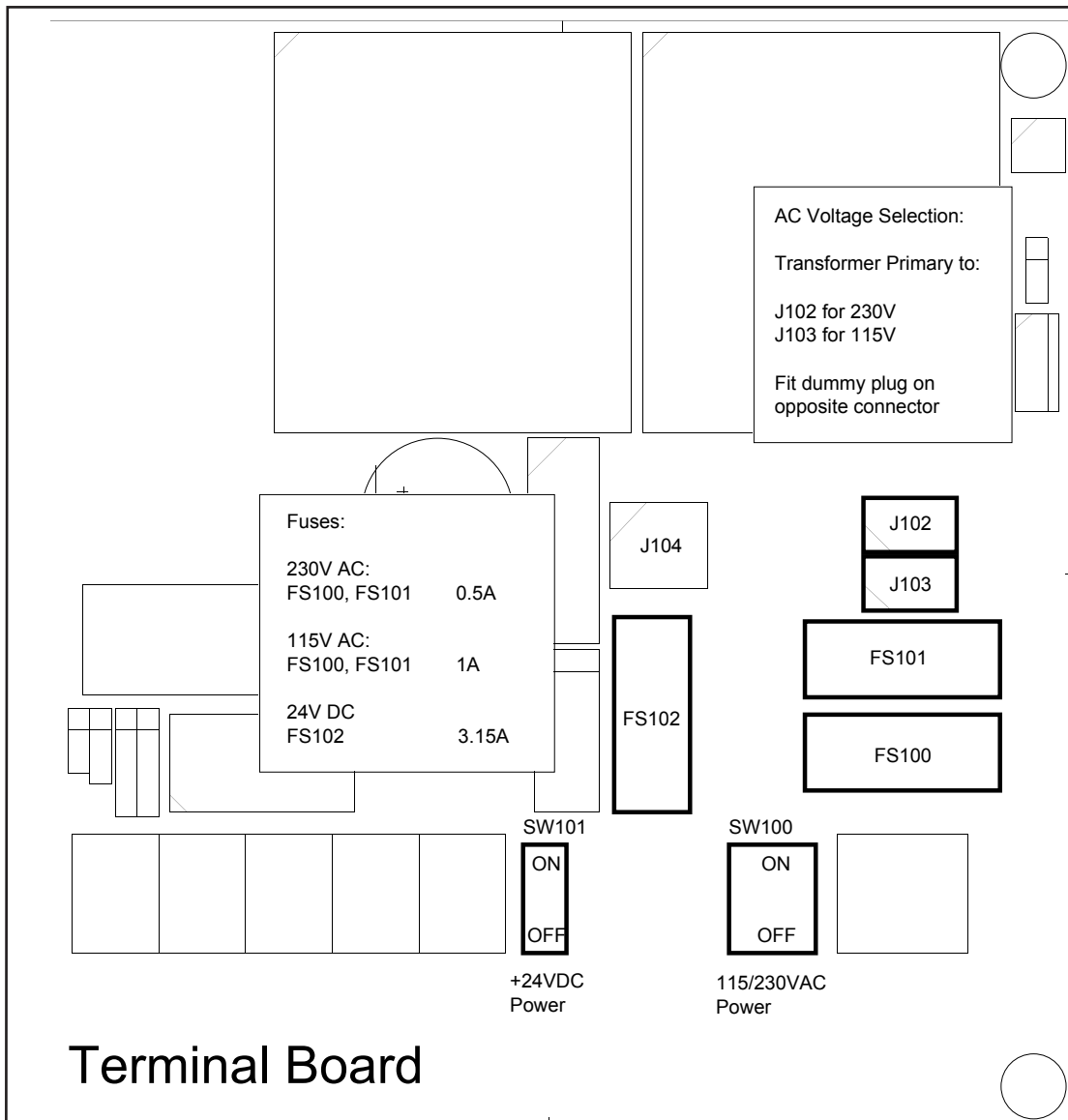
AC supply:	FS100, FS101	230 V	0.5 A	slow blow.
		115 V	1 A	slow blow.
DC supply:	FS102	24 V	3.15 A	slow blow.

When the installation is complete, and power is connected to the operator unit, the appropriate power switch by the power terminals is switched on. For daily operation, these switches may stay on and the unit is switched off by pressing the “SYSTEM off” button on screen 2. The unit is switched on by pressing any button.

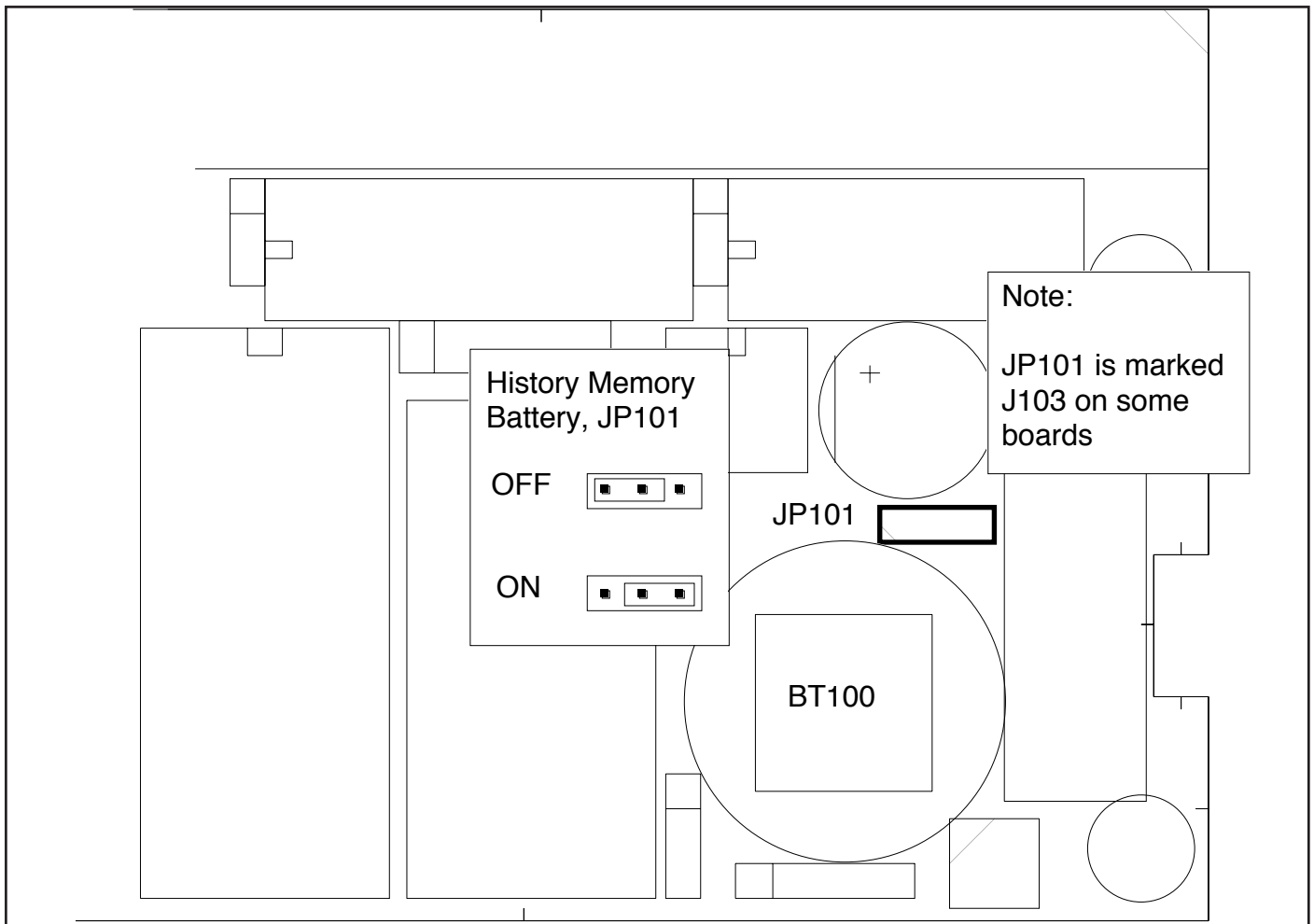
Both 115/230 V AC and 24 V DC power may be connected and switched on at the same time. If one of these supplies shuts down, changeover is automatic.

## **EMC**

**Important:** To meet the stringent EMC requirements for this type of equipment, two ferrite filters are supplied with the display unit. The transducer wires should be looped two times through these as shown in fig 9.4 in the appendix.

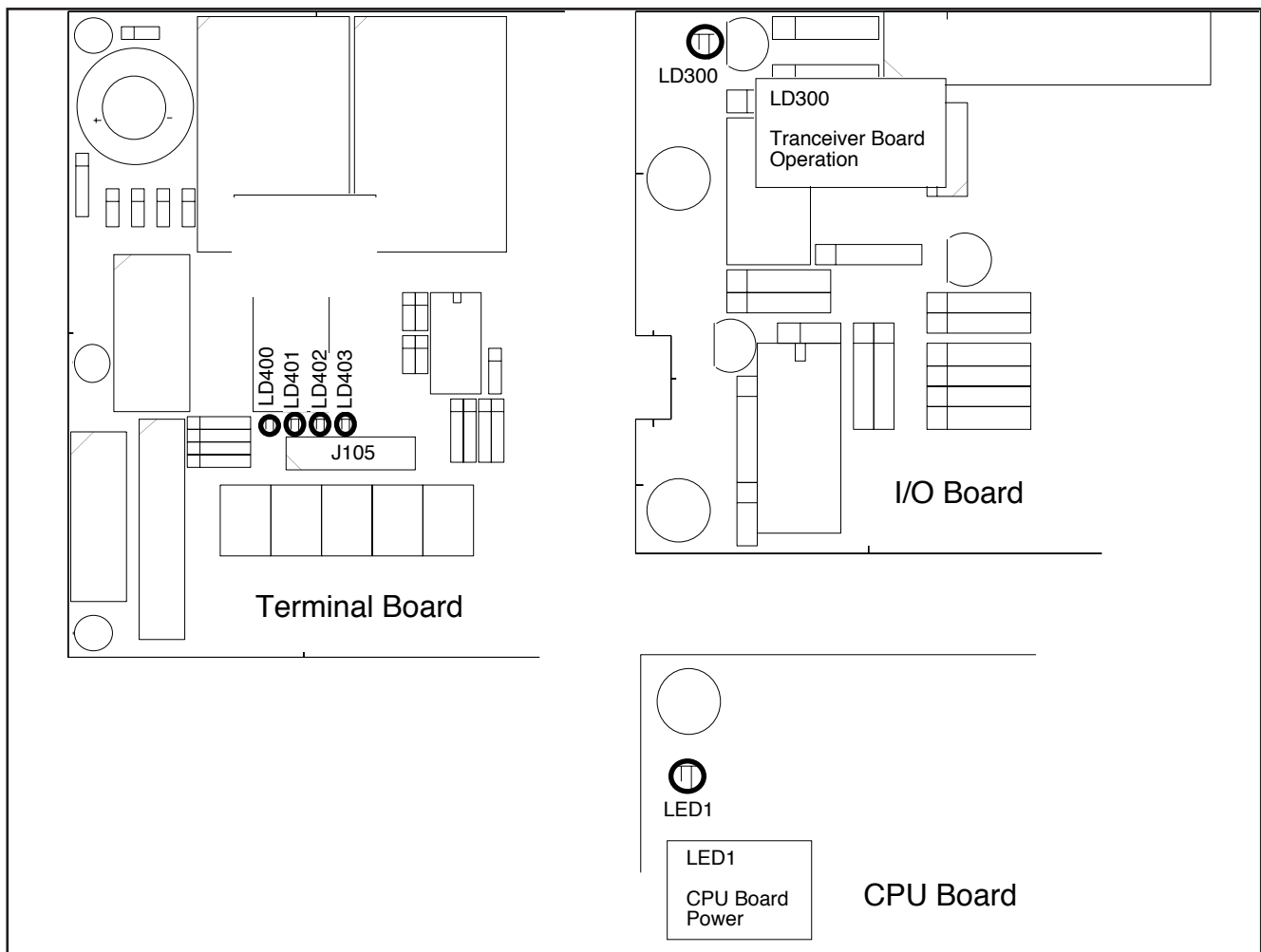


**Fig. 4.4. Voltage selection connectors and fuses, terminal board.**



**Fig. 4.5. History Memory Battery Jumper, I/O Board.**

**Note:** In the latest GDS101 versions, (starting from Sw 5.05.02) CMOS memory for storing “history” is not used. Here all values are stored on the Compact Flash. The jumper and battery is present only for backward compatibility.



**Fig. 4.6 Function LEDs, Terminal, I/O and CPU Boards.**

### Power Indication and function LEDs

The following LEDs are located on the terminal board:

- LD400: +5 V
- LD401: +12 V
- LD402: +12 V
- LD403: +48 V

The following function LED is located on the I/O Board:

- LD300 Transceiver board operation

There is one function LED on the CPU board:

- LED1 CPU board power



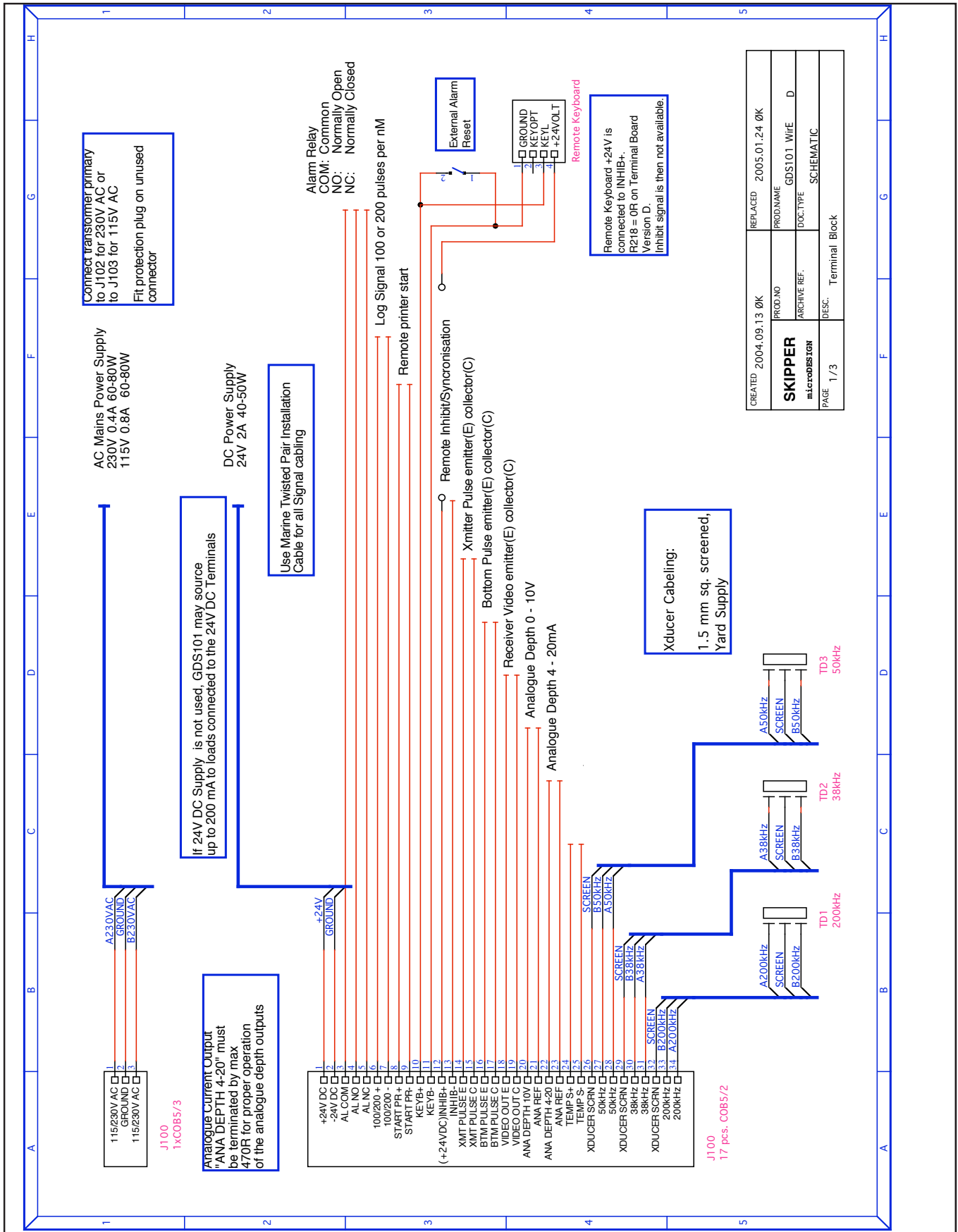


Fig. 4.7. Main Wiring Diagram.

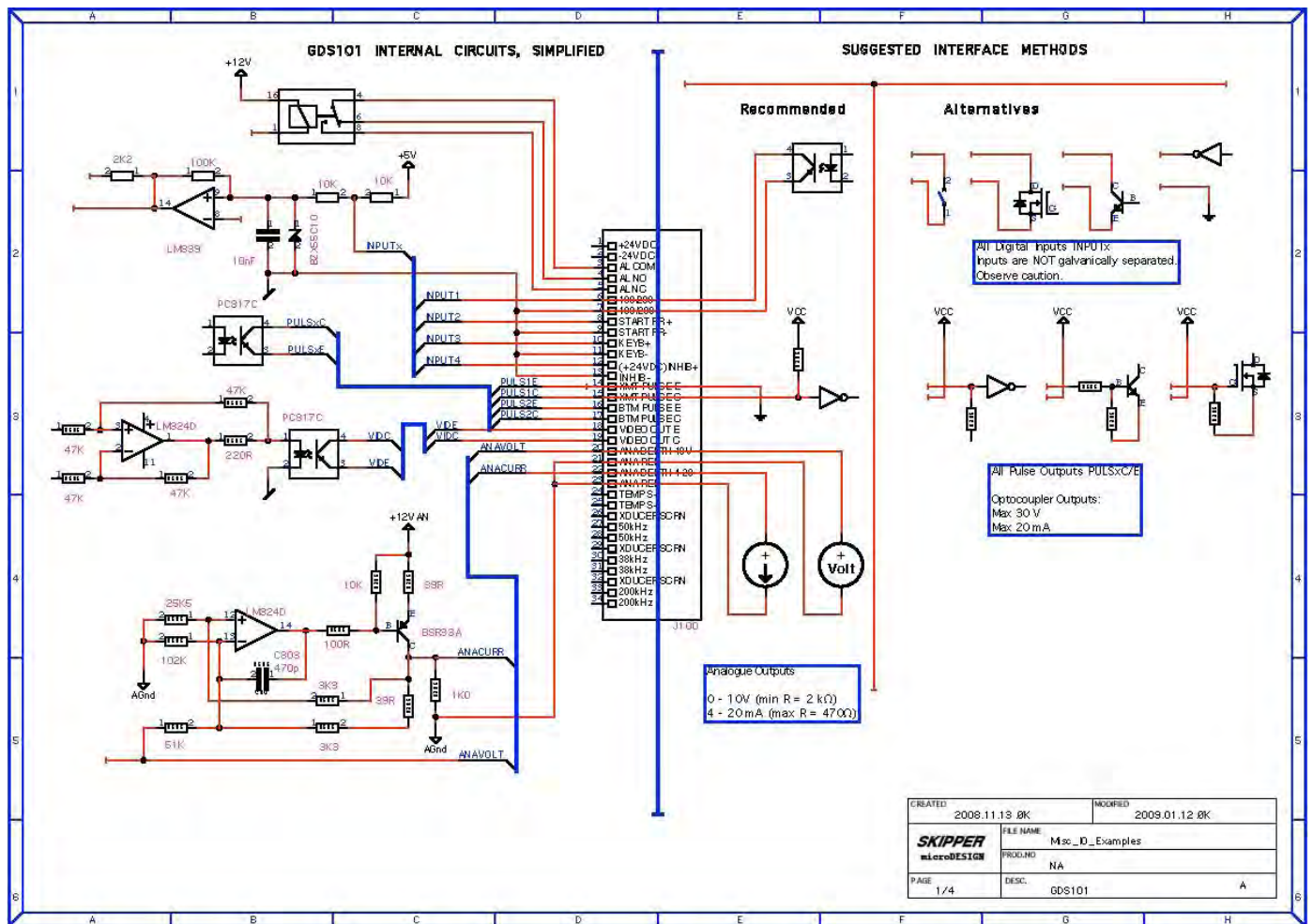


Fig. 4.8. Input/Output Circuitry.

### Interfacing

#### Alarm relay

An alarm relay is provided for interconnection to external alarm systems. This relay is normally energised, and is released by alarm conditions or power failure/power off. See fig. 4.7, 4.8 and 4.11. The terminals have the following significance:

Name	J100 pin no	Description
ALCOM	3	Common terminal.
ALNC	5	Normally closed contact (Normal = “No alarm” condition).
ALNO	4	Normally open contact.

**To comply with MED rules, it is mandatory to connect this output to an audible alarm system.**

#### External alarm reset function

- External alarm reset function.
- Can be connected at Keyb+/Keyb-, in parallel with external keyboard (if attached).
- External reset will disengage alarm relay and reset audio alarm (if enabled).
- Visual alarm (blinking digital depth indication) is not affected and must be reset locally by pressing any key on the panel.

External alarm reset terminals are as follows:

Name	J100 pin no	Description
KEYB+	10	External alarm reset control input +.
KEYB-	11	External alarm reset control input -.

### Log Pulse input

See fig. 4.7 and 4.8. Pulse input terminals are as follows:

Name	J100 pin no	Description
100/200 +	6	Log pulse input +.
100/200 -	7	Log pulse input -.

Refer to screen 6 for selection of the log pulse rate.

### Remote Transducer Selector FEEDB (Feedback)

See fig. 4.7 and drawing ENS518 in Appendix. Transducer selector control input terminals are as follows:

Name	J100 pin no	Description
STPRINT +	8	Transducer control input +.
STPRINT -	9	Transducer control input -.

Transducer selector FORWARD position: (open - FORWARD/PORT transducer selected).

Transducer selector AFT position: (closed - AFT/STARBOARD transducer selected).

### Transmitter and Bottom Pulse outputs

See fig. 4.7 and 4.8. Pulse output terminals are as follows:

Name	J100 pin no	Description
XMIT C	15	Collector of output opto coupler, transmitter pulse.
XMIT E	14	Emitter of output opto coupler, transmitter pulse.
BOTTOM C	17	Collector of output opto coupler, bottom pulse.
BOTTOM E	16	Emitter of output opto coupler, bottom pulse.

### Analogue interfaces

See fig. 4.7. GDS101 is equipped with analogue outputs to supply analogue repeaters or other equipment with analogue inputs. The signals are galvanically connected to the GDS101. Standard range is 0 - 10 V or 4 - 20 mA corresponding to Shallow Max, Deep Max Settings. These settings may be accessed on screen 5. Analogue outputs from the GDS101 have the following significance:

Name	J100 pin no	Description
ANA 10 V	20	Positive analogue voltage output.
ANA REF	21	Negative analogue reference.
ANA 20 mA	22	Positive analogue current output.
ANA REF	23	Negative analogue reference.

**NMEA interface**

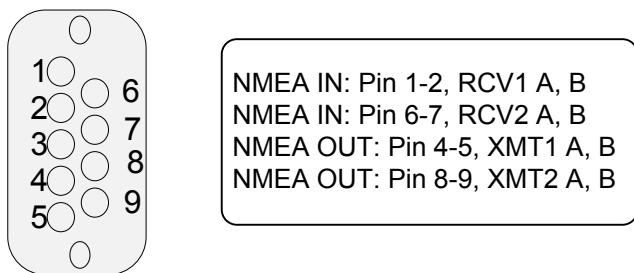
The NMEA outputs provides IEC 61162-1:2007(E) (NMEA 0183) format depth information to other equipment with NMEA 0183 inputs. Baud rate is 4800 or 9600, 8 bit, no parity. Several messages may be selected on screen 8 and the enabled messages are transmitted every second. The NMEA inputs accept position, speed, heading and UTC time messages from various navigators, compasses or speed logs.

The two inputs provided may be connected to different talkers, and both data streams will be received. There are two outputs that will drive each minimum of 10 standard NMEA 0183 inputs.

**Note:** Screen 8 NMEA control screen shows in the text window received or transmittet messages on the presently selected channel (NMEA 0183 or RS-232).

The NMEA 0183 outputs and inputs are available on the XJ303 9 Pin connector according to fig. 4.9, 4.10 and 4.12. See section 5, start-up and system adaptation, for a complete list of transmitted and received messages.

9 Pin D-SUB (female connector) in cabinet front seen from outside.



**Fig. 4.9. NMEA connector XJ303.**

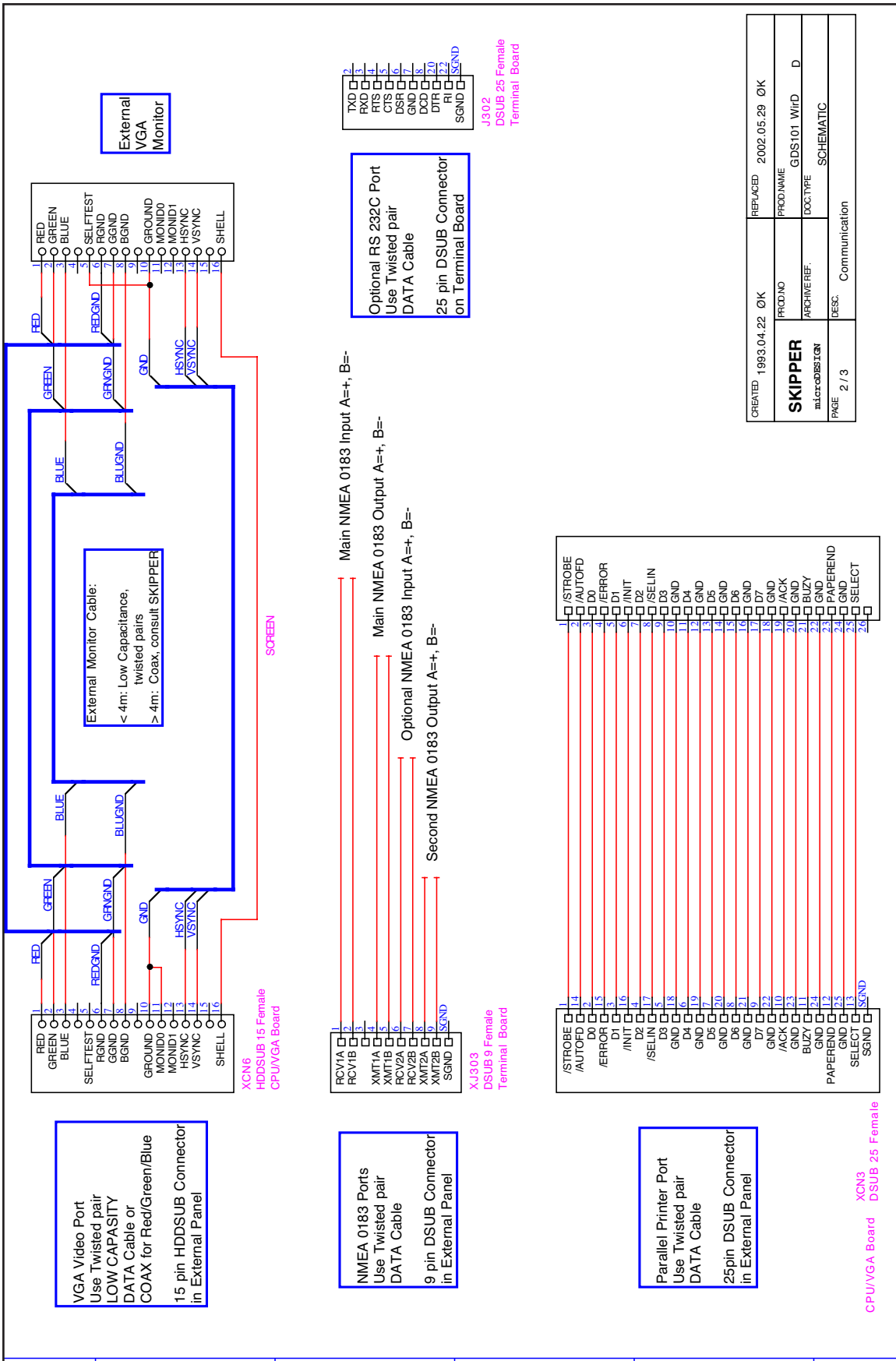
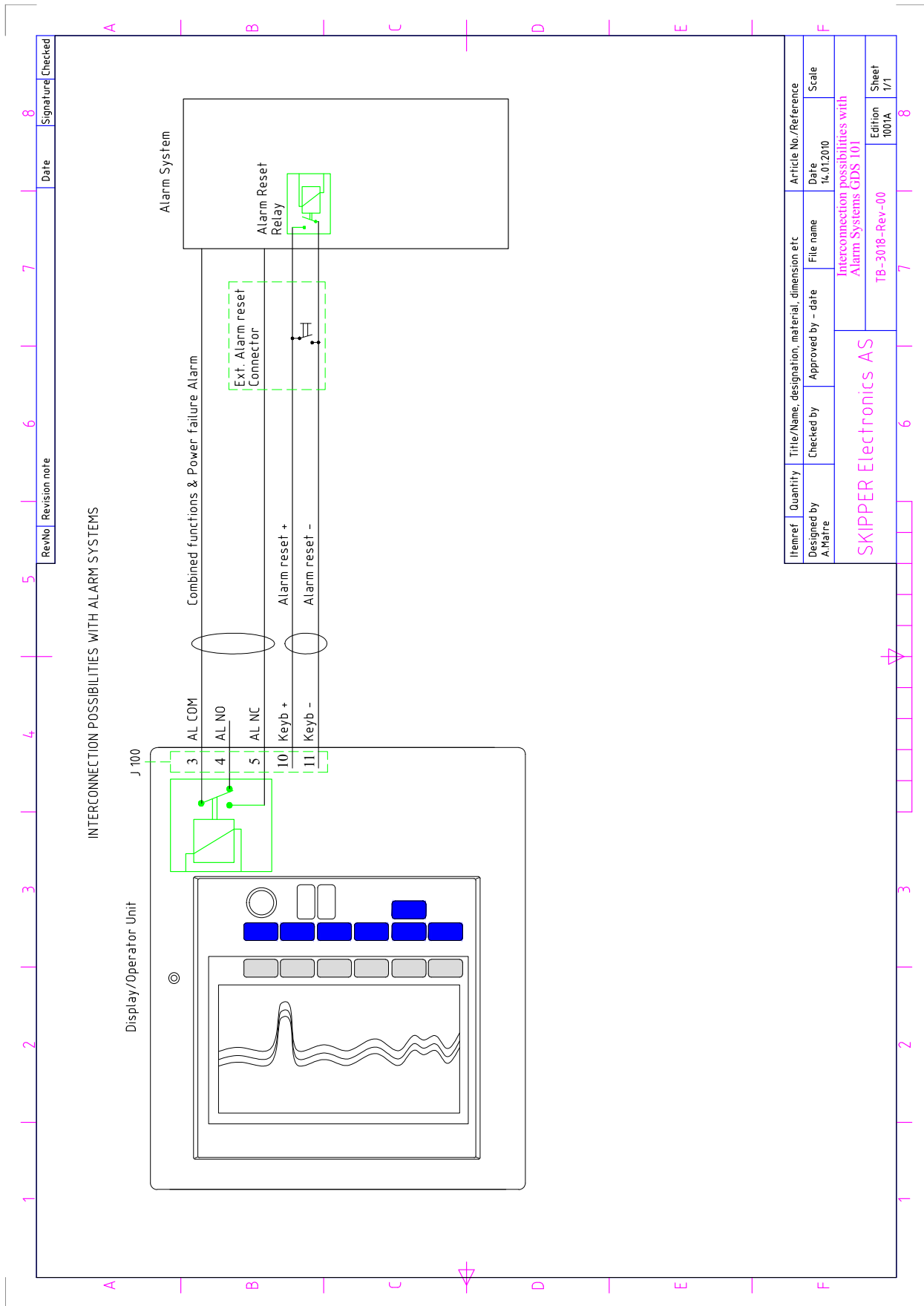


Fig. 4.10. Data Communication Interfaces.



**Fig. 4.11. Alarm interconnections**

## External Interface Ports



Ground Stud 5 x PG 13,5 cable entry 10-12mm

XJ303: NMEA ports D-type 9 pin female.

XCN6: VGA terminal HDD D-type 15 pin female.

XCN3: Printer port D-type 25 pin female.

Also, see fig. 4.9, NMEA connector and fig. 4.10, Data communication interfaces.

**Fig. 4.12. External Interface Ports**

## Options

### Repeaters/Slaves

Graphic CRT (VGA) or LCD displays or digital depth slave repeaters may be connected to the system. Along with the graphic display repeaters, there may also be installed remote keyboard. The graphic repeaters require the installation of line driver units dependant on the distance between the main system and the repeater. See fig. 4.7 and 4.10.

### Remote Keyboard

The unit may optionally be operated from a remote keyboard/hand controller. See fig. 4.7 and 4.8.

Name	J100 pin no	Description
KEYB-	11	Keyboard reference.
KEYB+	10	Keyboard signal.
+24 V DC (INHIB+)	12	Keyboard power.

### Remote Sounding Control.

This option lets the GDS101 being controlled remotely in synchronised, burst or single ping modes. If installed, these options are accessible on screen 3. See fig. 4.7 and 4.8.

Sounder remote control terminals are as follows:

Name	J100 pin no	Description
INHIB +	12	Control Signal Input +.
INHIB -	13	Control Signal Input -.

Refer to screen 6 for selection of the control signal polarity.



## 5. Start-up and system Adaption

### System Adaptation

#### Analogue Output and Log Pulse Input Range Selection

From screen 6 it is possible to set number of pulses per nautical mile (100, 200, 400 and 20000) for the log pulse input. Shallow and deep range limits for the analogue output may also be set, e.g.

- 50 m corresponding to 10 V or 20 mA.
- 0 m corresponding to 0 V or 4 mA.

#### Language and Units of Measure

From screen 5 it is possible to select different languages and units of measure for the screen and printer character strings. The available languages are: English, French, Spanish, Russian, German and Norwegian.

Units of measure may be selected for:

Depth	meters, feet, fathoms, braccias.
Picture speed	min:sec, nm/div, km/div, miles/div.
Vessel speed	knots, km/h, miles/h.
Sound speed	m/s, feet/s

#### Remote Transducer Selector

See fig. 4.7 and 4.8. Transducer selector control input terminals are as follows:

Name	J100 pin no	Description
STPRINT +	8	Transducer control input +.
STPRINT -	9	Transducer control input -.

STPRINT-/STPRINT+ input is processed as transducer selector input (open - FORWARD/PORT transducer selected, closed - AFT/STARBOARD)

#### Low frequency indication

When the 38 kHz transceiver channel has been modified to a different frequency, it is possible from screen 5 to adjust indicated value. Soft key SET LOW has five preset values (24/28/30/33/38 kHz) and encoder must be used to set any other value in the range of 10 - 50 kHz, when desired. Note that the 38 kHz channel must be activated first (Screen 2, button "FREQUENCY"). **Note:** After master reset procedure, the value is reset to factory default, and should be re-entered, if the actual value is different.

### NMEA Setup

Screen 8 is used for verification of received and control of transmitted NMEA messages. Two digital communication channels are provided:

- Primary NMEA 0183, (XJ303, RCV1A/B-XMT1A/B)
- Secondary NMEA 0183/RS-232 C, (XJ303 NMEA: RCV2A/B-XMT2A/B) and J302 (RS-232C).

Each channel can be programmed individually with respect to the baud rate and scope of transmitted messages. Before configuring of the required channel, it must be selected by using the soft key IN/OUT. Primary channel is called NMEA, while secondary marked RS-232 (both RS-232 and NMEA outputs are available on different connectors). Note, that text window will represent information, which corresponds to the currently selected channel. The type of displayed messages received from external talker (if connected) or transmitted by the sounder, is selectable by using the soft key DISPLAY input/output. For more easy analysis of the window contents, display can be prevented from continuous update, if “DISPLAY off” is selected. The baud rate may be set to 4800 or 9600, 4800 being the more common.

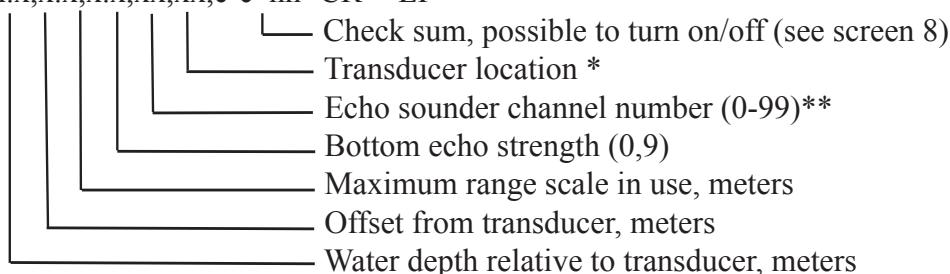
Transmitted messages are enabled individually by soft keys MESSAGE and STATUS. To enable/disable particular message, select it from the list by pressing MESSAGE button until required message appears on the same button and then select the status of this message (on/off) by pressing STATUS button. It is advisable at this stage to set display in “output” mode, to be able to observe current scope of transmitted messages.

Transmitted talker identifier is SD, Sounder Depth. The following NMEA 0183 messages may be transmitted:

Depth & Draught	\$SDDPT,xxxx.x,xxxx.x,xxxx.x*hh<CR><LF>
Depth below surface	\$SDDBS,xxxx.x,f,xxxx.x,M,xxx.x,F*hh<CR><LF>
Depth below transducer	\$SDDBT,xxxx.x,f,xxxx.x,M,xxx.x,F*hh<CR><LF>
Depth below keel	\$SDDBK,xxxx.x,f,xxxx.x,M,xxx.x,F*hh<CR><LF>
[Fore/Aft] transducer	\$SDXDR,D,x,x,M,c-c,<Cr><Lf>

In case of multiple transducer installation, the following SKIPPER proprietary sentence must be selected:

\$PSKPDPT,x.x,x.x,x.x,xx,xx,c-c\*hh<CR><LF>



\* Text string, indicating transducer position: FWD/AFT/PORT/STB. If position is not preset by operator, empty field is provided.

- \*\* = 1 - 38 kHz  
 = 2 - 50 kHz  
 = 3 - 200 kHz

The following messages are accepted for input. The talker identifier is ignored:

### Time

Universal Time	ZZU,xxxxxx
Universal Time & Local	ZLZ,xxxxxx,xxxxxx,-xx
Day, Month, Year	ZDA,xxxxxx,xx,xx,xxxx,-xx

### Position

Geographical Lat/Lon	GLL,xxxx.xx,N,xxxxx.xx,W
Geographical Fix, present	GXP,xxxxxx,xxxx.xx,N,xxxx.xx,W,cccc,x
Loran C Fix, present	GLP,xxxxxx,xxxx.xx,N,xxxx.xx,W,cccc
GPS Position	GGA,xxxxxx,xxxx.xxx,N,xxxxx.xxx,W,x

### Heading

Heading, true, present	HDT,xxx.,T
Heading, magnetic, present	HDM,xxx.,M
Heading, compass	HCC,xxx.

### Speed

Dual Doppler Vector	VBW,uxx.xx,uxx.xx,a,uxx.xx,uxx.xx,a
---------------------	-------------------------------------

### Composite

Loran C specific	RMA,a,xxxx.xx,N,xxxxx.xx,W,,,xx.x,xxx.,*xx
GPS, Transit specific	RMC,xxxxxx,a,xxxx.xx,N,xxxxx.xx,W,xx.x,xxx.,xxxxxx,*xx
Track & Ground speed	VTG,xxx.,T,xxx.,M,xx.x,N,xx.x,K
Heading & Water speed	VHW,xxx.,T,xxx.,M,xx.x,N,xx.x,K

## Options

### Calibration, Sound Speed

The only calibration activity necessary is when the sound speed option is installed. In this case, set the required sound speed value in screen 3.

### External Ping Control

When this option is installed, transmitter operation may be controlled by the external INHIBIT signal. The active polarity of this signal may be set on screen 6. The following function options are available on screen 3:

### PING

<b>Continuous</b>	Transmitter operation is continuous and not affected by the external signal.
<b>Edge</b>	The transmitter is activated <u>once</u> by an active signal edge.
<b>Level</b>	The transmitter is controlled by the external signal level. An active level keeps the transmitter running, a passive level stops the transmitter.
<b>Single</b>	The transmitter is activated ping by ping by pressing the PICTURE SPEED button on the operator panel. The external INHIBIT signal is disabled.

## 6. Specifications, Dimensions

<b>Transducer, 38 kHz</b>	Diameter.	181 mm.
	Mounting.	Tank/sea valve /ice tank.
	Cable length.	40 m.
	Weight.	ca. 20 kg.
	Protection.	IP 68.

<b>Transducer, 50 kHz</b>	Diameter.	90 mm.
	Mounting.	Tank/ sea valve/ice tank/aluminium tank.
	Cable length.	25 m or 40 m.
	Weight.	ca. 7 kg.
	Protection.	IP 68.

<b>Transducer, 200 kHz</b>	Diameter.	140 mm.
	Mounting.	Tank/ice tank.
	Cable length.	25 m or 40 m.
	Weight.	ca. 8 kg.
	Protection.	IP 68.

<b>Transducer, 200 kHz</b>	Diameter.	90 mm.
	Mounting.	Tank/sea valve/ice tank/aluminium tank.
	Cable length.	25 m.
	Weight.	ca. 7 kg.
	Protection.	IP 68.

<b>Transducer Junction Box</b>	Size incl. glands.	132 x 111 mm.
	Depth.	55 mm.
	Weight.	0.6 kg.
	Protection.	IP 56.

<b>Operator unit cabinet</b>	Height, front.	340 mm.
	Width.	320 mm.
	Depth.	170 mm.
	Weight.	ca. 10 kg.
	Protection.	IP 23.

## Functional Properties

<b>Display.</b>	10,4" 158 x 211 mm graphic LCD screen with adjustable day/night vision and backlight. 640 x 480 pixels.
<b>Printer.</b>	HP Deskjet, Epson D88 or Epson LQ300.
<b>Depth alarms.</b>	Deep and shallow limits.
<b>Calendar/Clock.</b>	Year-month-day/hours-minutes-seconds (24 hour system).
<b>Interface outputs.</b>	Trigger and bottom pulses.
	Analogue 4 - 20 mA and 0 - 10 V for depth. Detected video.
	IEC 61162-1:2007(E) (NMEA 0183) for depth.
	Alarm relay.
	Output for VGA repeater.
	RS-232 C.
	PC parallel printer port.
<b>Interface inputs.</b>	100/200/400/20000 pulses for speed.
	IEC 61162-1:2007(E) (NMEA 0183) for speed, position, heading and time.
	Remote alarm reset.
	Remote transducer selector.
<b>Languages.</b>	English, French, Spanish, Russian, German and Norwegian.
<b>Options.</b>	VDR (Voyage Data Recorder) or IR301 digital remote depth indicator.
	LCD repeater.
	Remote keyboard.
	Remote sounding control.
	Auto range.
	Sound speed calibration.

## Performance

<b>Depth range.</b>	0 - 1600 m.
<b>Graphic resolution.</b>	0.5 % of range.
<b>Digital screen resolution.</b>	<10 m: 0.01 m.
	>= 10 m <100 m: 0.1 m.
	>= 100 m: 1 m.

<b>Transducer, 24 kHz/38 kHz.</b>	Beam angle.	16°/20° conical.
	Max. power.	1 kW.
	Effective range.	3000 m/2000 m.
<b>Transducer, 50 kHz.</b>	Beam angle.	33° conical.
	Max. power.	1 kW.
	Effective range.	1000 m.
<b>Transducer, 200 kHz.</b>	Beam angle.	6° conical.
	Max. power.	1 kW.
	Effective range.	500 m.
<b>Transducer, 200 kHz.</b>	Beam angle.	10° conical.
	Max power.	1 kW.
	Effective range.	300 m.

**Environmental according to IEC60945:****Transducer and Junction Box**

<b>Operating temperature.</b>	-15 - 55 degree C IEC 60945
<b>Storage temperature.</b>	-20 - 70 degree C
<b>Protection, transducer.</b>	6 bar, IP 68
<b>Protection, parts inside hull.</b>	IP 56

**Operator Unit Cabinet**

<b>Supply voltage.</b>	230 V (195 - 253 V AC) or 115 V (96 - 125 V AC).
	24 V DC (20 - 32 V).
<b>Power consumption.</b>	50 W at 24 V, 70 W at 230 V or 115 V.
<b>Alarm relay.</b>	Change-over contact, max. 24 V 300 mA.
<b>RS-232 C port.</b>	Standard 25 pin D - type connector (located on terminal PCB inside cabinet).
<b>NMEA port.</b>	9 pin D - type. 2 inputs, 2 outputs.
<b>Operating temperature.</b>	-15 - 55 degree C according to IEC 60945.
	To increase serviceability and life-time, we suggest the working temperature to be held at 0 - 40 degree C.
<b>Storage temperature.</b>	-20 - 70 degree C.
<b>Humidity.</b>	10 - 90 % relative, no condensation.
<b>Protection.</b>	IP 23.

## **7. Service**

---

- All service requests should be made to your local representative or to the manufacturer. (Contact information on title page).
- Adjustments and repairs should only be performed by qualified service engineers.
- Unqualified repair attempts will void the warranty.

## 8. CPU Board Setup Procedure

---

### CPU PCA 6742VE

(Bios version 1.12). The PCA 6742 has the default settings with the following changes. Start by loading the optimized defaults, and then change the following:

#### STANDARD CMOS FEATURES

Date: Change to todays date

Time: Change to time now

Halt on: No errors

#### Advanced BIOS Features

- a. Hard Disk priority [Press enter] – Press enter
  - i. 1 should be ch.1 M.
  - ii.2 should be ch 0 M.
- b. First Boot Device [Hard Disk]
- c. Second Boot Device [Hard Disk]
- d. Boot other device [Disabled]

#### Advanced Chipset features

- a. SMI712 VGA Settings [Press Enter] – Press enter
  - i. SMI712 VGA Monitor [Simul monitor]
  - ii. Panel resolution Mode [640x480 TFT]
- b. USB Device Setting [Press Enter] – press enter
  - i. USB1.0 emulation [Disabled]

#### Integral Peripherals

- a. Onboard serial Port 3 [enter]
  - i. Change to [2E8/IRQ9]
- b. Onboard serial Port 4 [enter]
  - i. Change to [3E8/IRQ5]
- c. Parallel Port Mode [EPP]
- d. EPP Mode Select [EPP1.9]

#### PnP/PCI Configurations

- a. Resources Controlled By [Manual]
- b. IRQ Resources [Enter]
  - i. IRQ – 7 assigned to [Legacy ISA]
  - ii. IRQ – 10 assigned to [Legacy ISA]
  - iii. IRQ – 11 assigned to [Legacy ISA]
- c. NO DMA

#### PC Health Status

- a. Case Open Warning [Disabled]

SAVE SETTINGS AND EXIT



## Master Reset Procedure

After completed setup procedure, you should always do a ‘MASTER RESET’:

- Switch off the GDS101, using the internal toggle switch and wait a few seconds.
- Then press down and keep pressed the soft key to the far right and far left (no. 1 and 6) in the upper row on the GDS101 keyboard.
- Turn the GDS101 ‘on’ and keep the two soft keys pressed down until the screen shows the normal picture. This may take as long as app. 30 seconds. You should normally hear 4 ‘beeps’ at the end of the procedure.

## Upgrading Software

New software versions are released from time to time. The GDS101 with Compact Flash (CF) can be updated by performing the following software upgrade procedure.

1. If you have received a programmed compact flash, skip stage 2.
2. Copy the received/downloaded software file into the root folder of Compact Flash card. The name of the file is not relevant. Also copy the latest version of setup.exe into the root folder.

**Note:** Standard Compact Flash reader is needed to be attached to the PC.

**Note:** It is possible to use the Compact Flash card, which is already installed in the display unit.

3. Switch OFF the mains of the display unit and insert Compact Flash card with the new software on it.
4. Press the ‘hidden’ button inside the cabinet (mounted on the solder side of the keyboard). Keeping the hidden button pressed, switch ON the mains in the display unit and keep the button pressed while the message ‘You may release the hidden button’ appears in the lower part of the screen. If a new setup.exe is to be loaded, follow the on screen instructions.
5. Release the hidden button. After few diagnostic text messages, the list of available software versions will appear in the lower part of the screen as in example below.
6. Note: If the bootloader does not find any file with the software on the Compact Flash, the presently installed version will start automatically. In this case, make sure that the upgrade and setup file has been copied correctly on the Compact Flash and repeat procedure.

05.05.06	05.05.09
Active	External

7. Select a software version, which you would like to install. Normally, it is possible to chose one out of two: 1) The version, which is currently installed in the internal memory (indicated as Active) and 2) the upgrade version (indicated as External). The version name is displayed in the upper line of the text lines, located just above the corresponding soft key. In the example above, soft key #2 should be pressed to select the latest software version.
8. Confirm selection by pressing YES button (or go back to selection, pressing NO).
9. Press any button to start the upgraded software (or it will start automatically in 5 seconds).
10. Note: The file with a previous software version will be copied back to the Compact Flash card, so it would be possible to re-install it in the similar manner, if desired.

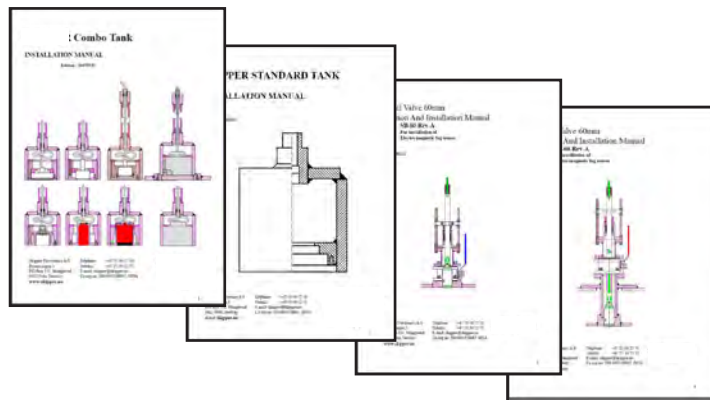
## 9. Appendix Miscellaneous Installation Drawings

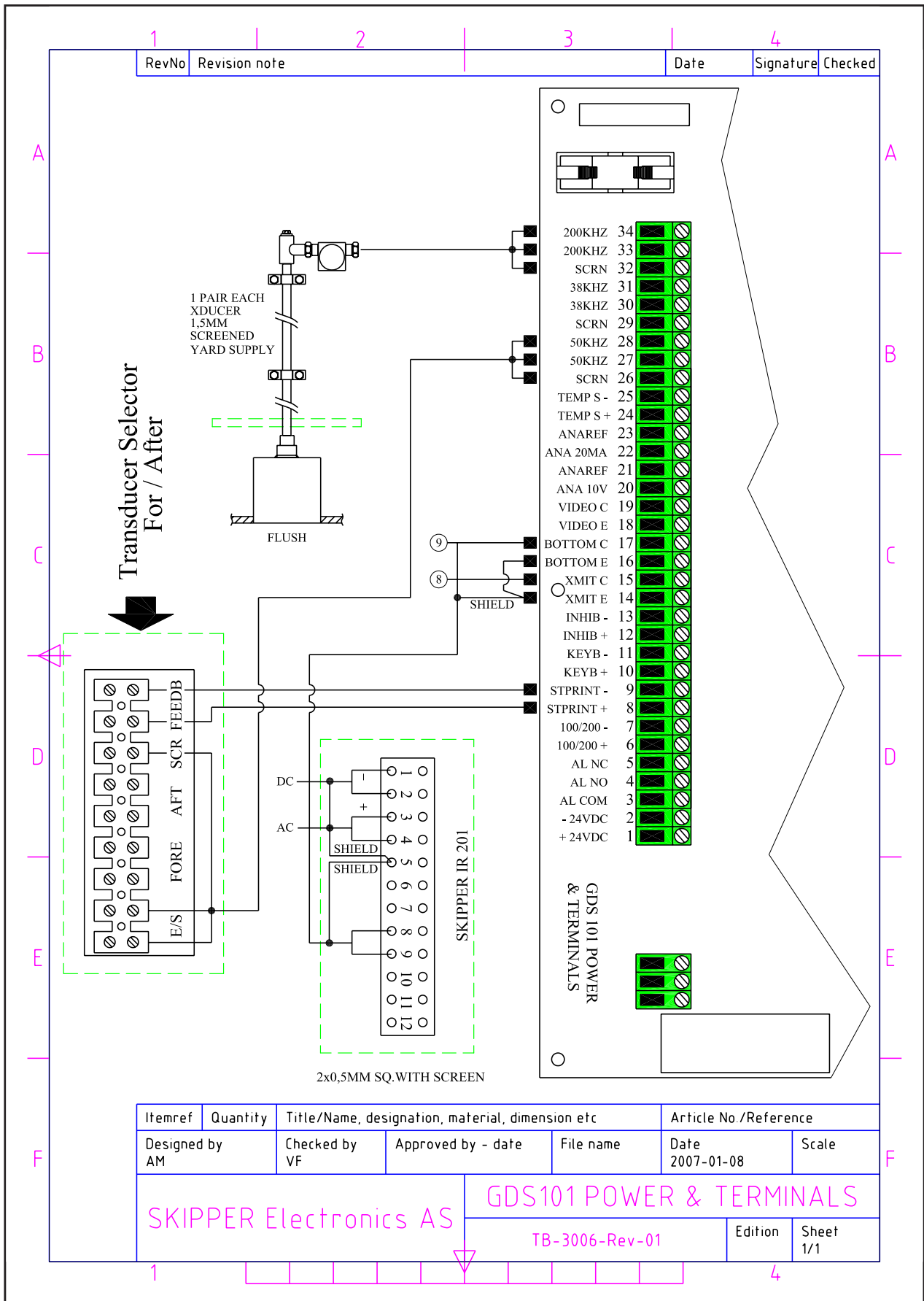
For repeater and repeater dimmer, see separate manual: IR301 manual

For tank and sea valve, see separate manuals:

ETNSLJB-manual.	Single bottom sea valve (discontinued from 2007).
SB-100-manual.	Single bottom sea valve (from 2007).
DB-100-manual.	Double bottom sea valve (from 2007).
SB-200-manual.	For 24 and 38 kHz transducer deep sea.
Standard tank inst manual.	For 50 and 200 kHz transducer.
Combo tank inst manual.	For 24 and 38 kHz transducer deep sea. For different type of transducers, custom design is possible.

All manuals (examples below) available on manufacturers homepage. (See title page for details).





**Fig 9.1 Transducer Selector Connection**

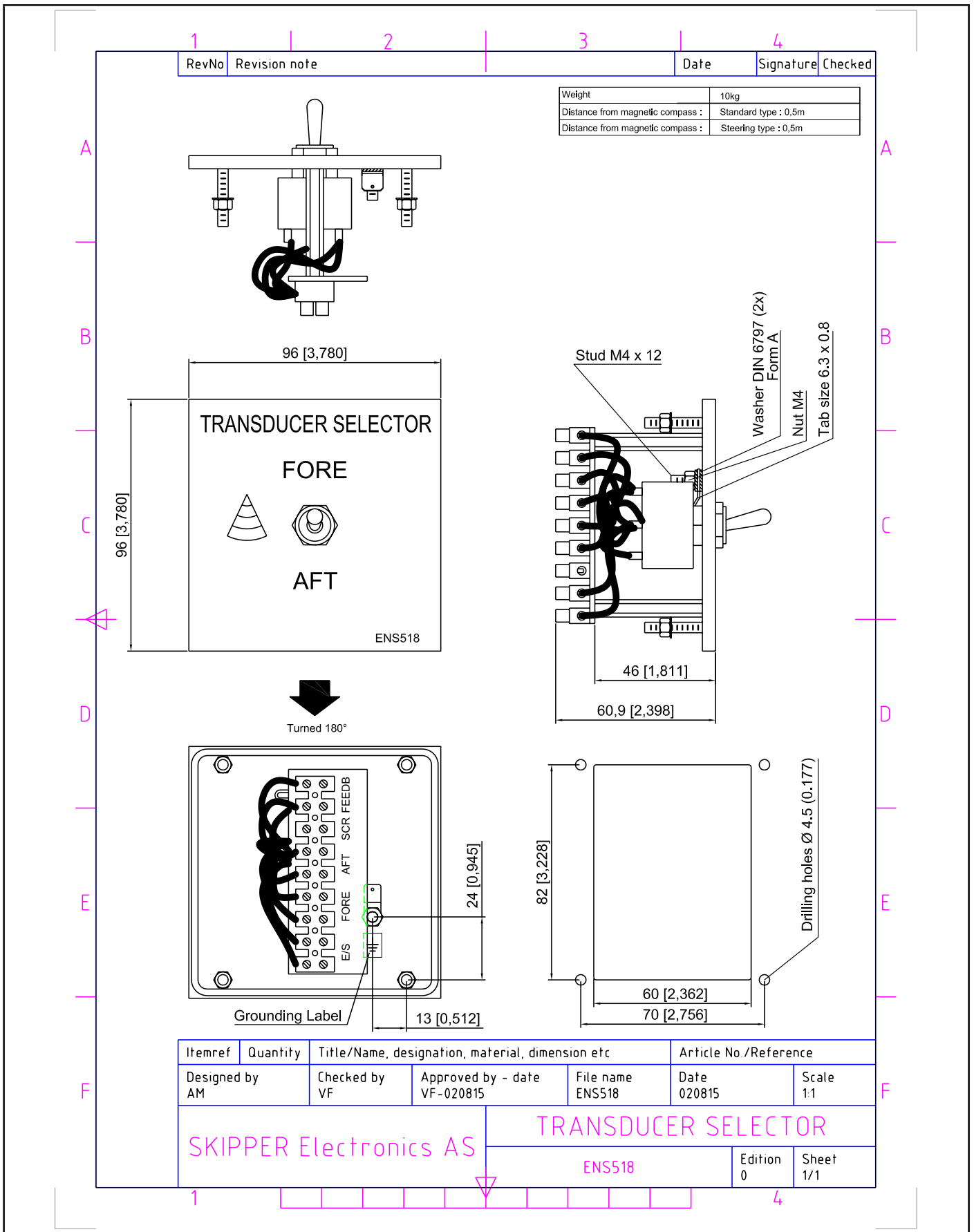


Fig 9.2 Transducer Selector

1		2		3		4
RevNo	Revision note			Date	Signature	Checked

**1. Straight braided screen**

**2. Twisted backward .....braided screen**

*The assembly of cable gland is quick and easy:*

1. Partially expose the braided screen by removing the outer sheath of the cable at a length of approx. 10 mm
2. Insert the cable through the dome nut and the gland body until the contact spring is pressed against the braided screen.
3. Firmly screw on dome nut .

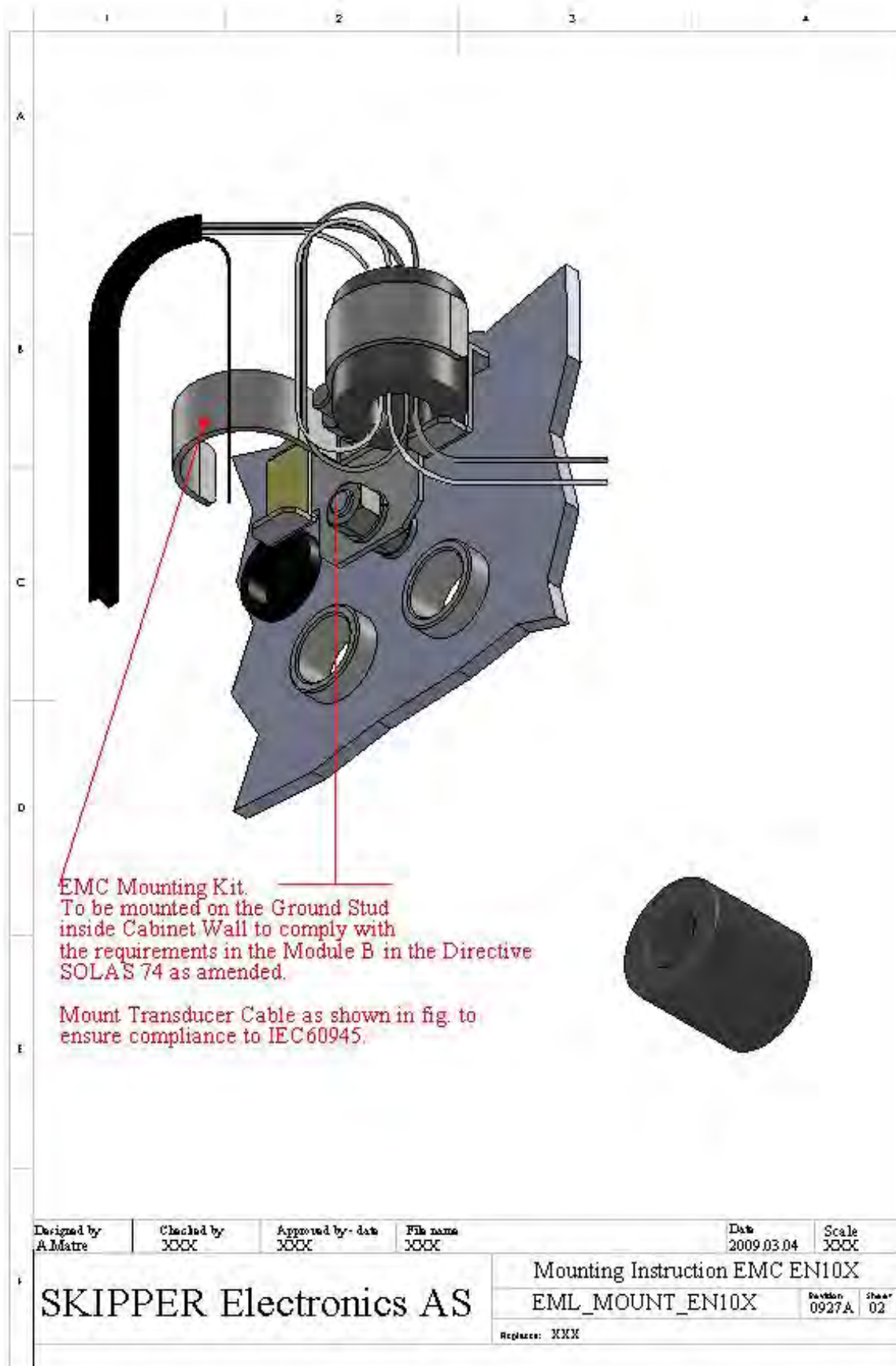
  

*Cable glands play an important part in safeguarding EMC requirements where cables and leads enter into a shielding system. They have to ensure a permanent connection with very low ohmic or inductive resistance between the cable shield and the housing potential.*

Itemref	Quantity	Title/Name, designation, material, dimension etc			Article No./Reference	
Designed by AM	Checked by VF	Approved by - date VF - 2006.12.18	File name	Date	Scale	
SKIPPER Electronics AS			EMC Cable Gland Connection			
			TB-3015-Rev-00	Edition	Sheet 1/1	

**Fig 9.3 Cable Gland Connection**



**Fig 9.4 EMC Mounting Kit**